

B 10 > 13A1450D600 (2003) > MÄHWERKSAUSHEBUNG

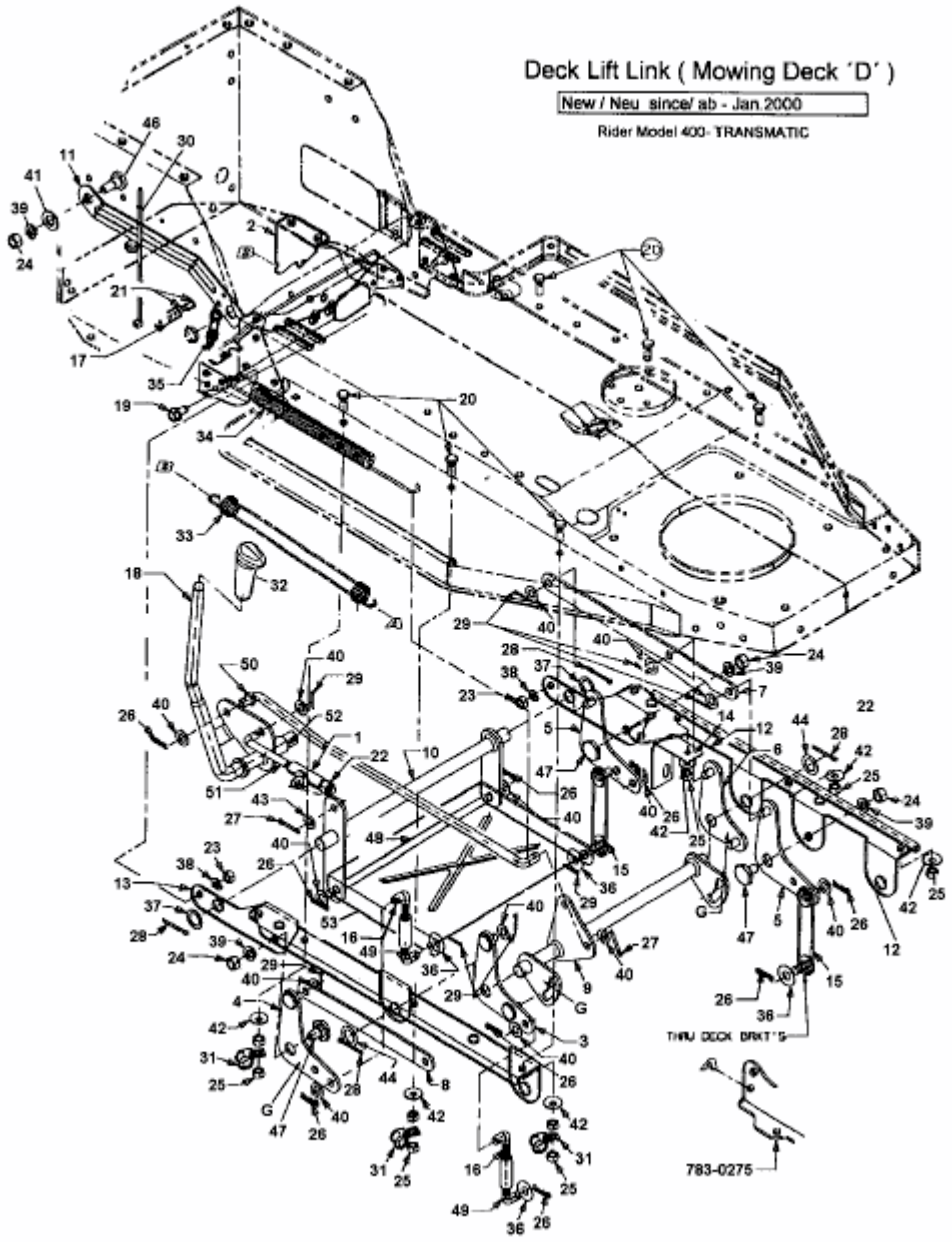

fig

E3-01591A-01