

RH 115 > 13A1450C600 (2002) > SCHALTPLAN EINZYLINDER

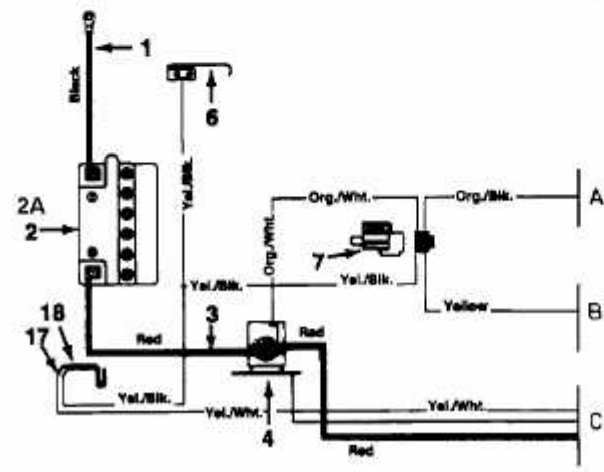
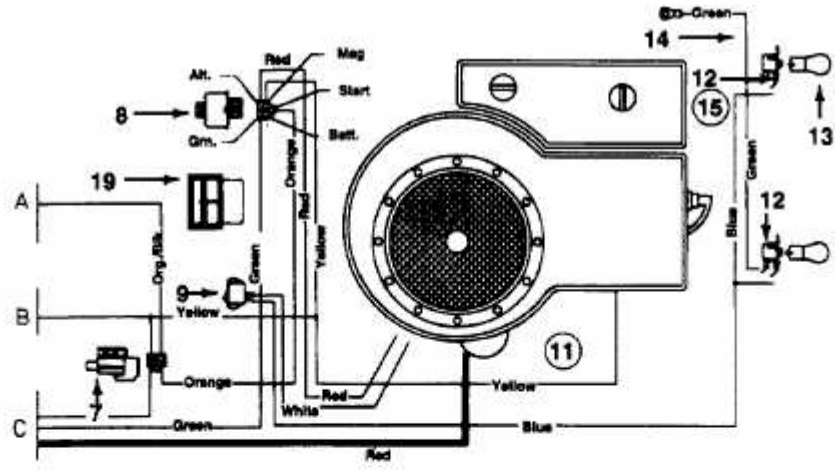

E3-01306A-01