

DX 70 > 13A-334-643 (2004) > LENKUNG, VORDERRAHMEN

SPRINTO 13A-312-678 , 13A-315-678 , 13A-332-678

DX 70 13A-315-643 , 13A-334-643

SC EDITION 13A-315-690 , 13A-334-690

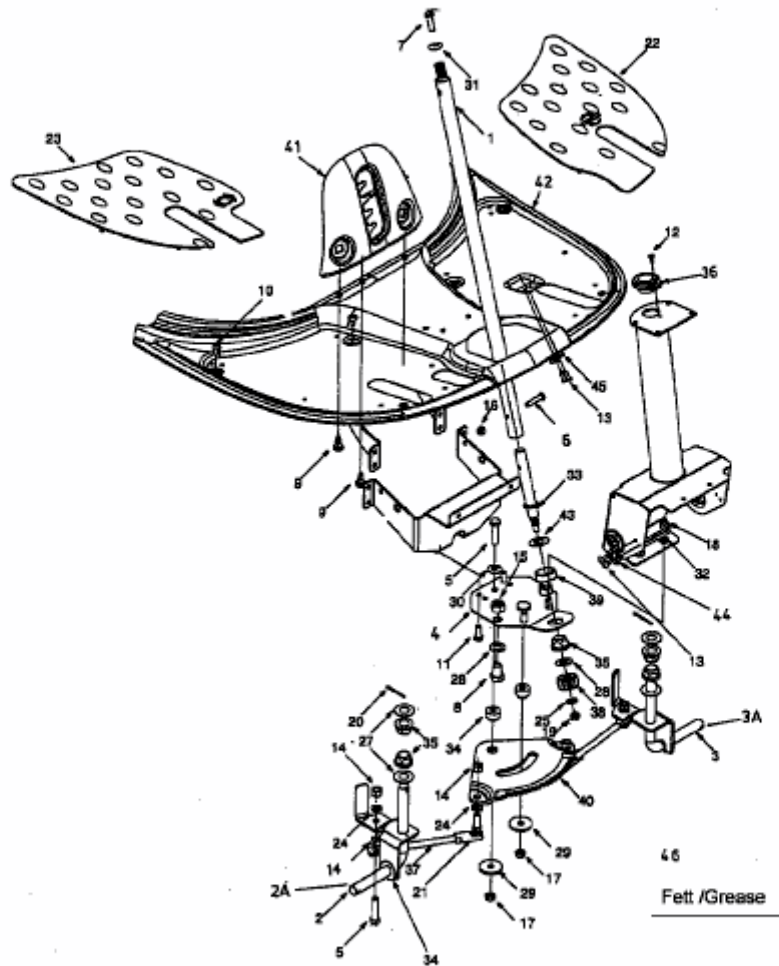

E4-00722 B