

SPRINTO > 13A-320-678 (1998) > SCHALTPLAN

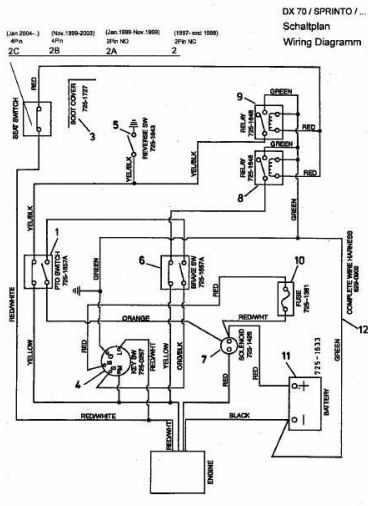

E4-00736B