

SPRINTO > 13A-320-678 (1998) > ANHÄNGEKUPPLUNG,
LENKUNGSSCHUTZ, STOSSSTANGE

Optional for Series 325-328

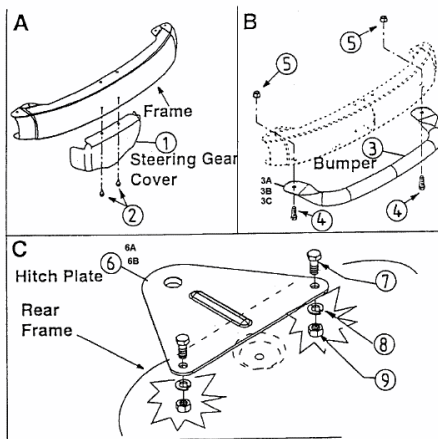

E3-01356 A