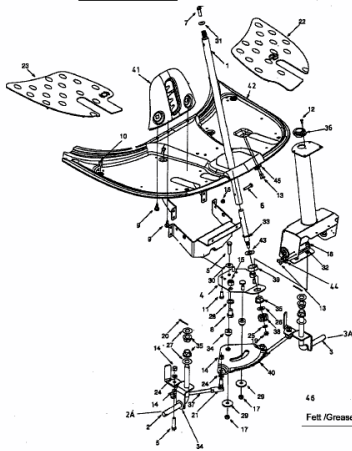

## SPRINTO &gt; 13A-320-678 (1998) &gt; LENKUNG, VORDERRAHMEN

SPRINTO 13A-312-678, 13A-315-678, 13A-332-678DX 70 13A-319-643, 13A-334-643SC EDITION 13A-315-690, 13A-334-690

E4-00722 B