

SPRINTO > 13A-315-678 (2000) > SCHALTPLAN

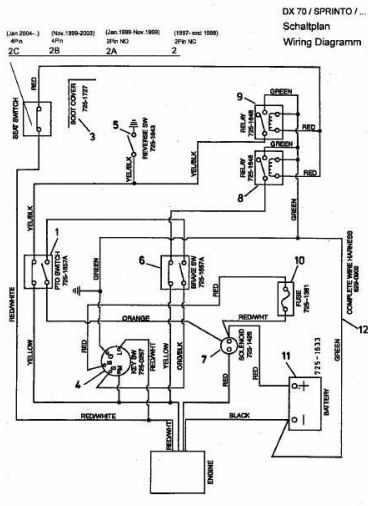

E4-00736B