

SPRINTO > 13A-315-678 (2000) > ANHÄNGEKUPPLUNG,
LENKUNGSSCHUTZ, STOSSSTANGE

Optional for Series 325-328

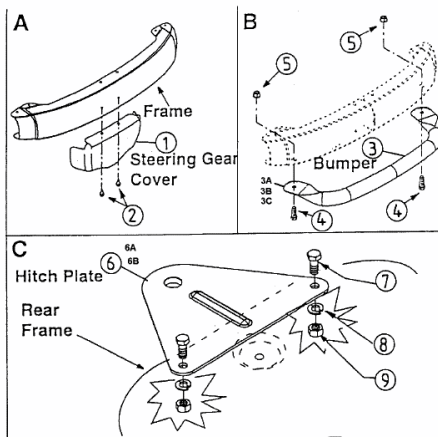

E3-01356 A