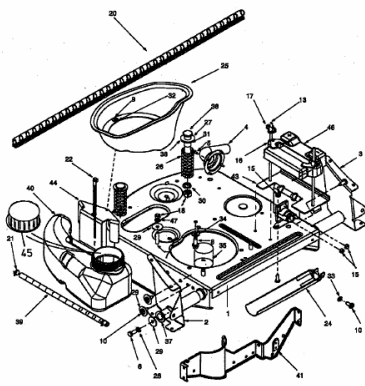

SPRINTO > 13A-315-678 (2000) > RAHMEN, TANK

Rahmen / Chassis
FrameModelle mit B&S-Motor
Models w/ B&S-Engines

E4-00728 A