

SPRINTO > 13A-315-678 (1999) > SCHALTPLAN

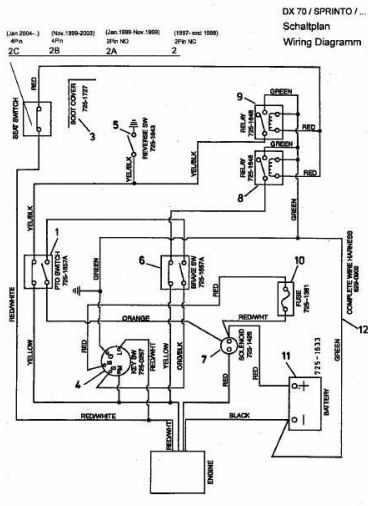

E4-00736B