

SPRINTO > 13A-312-678 (2002) > SCHALTPLAN

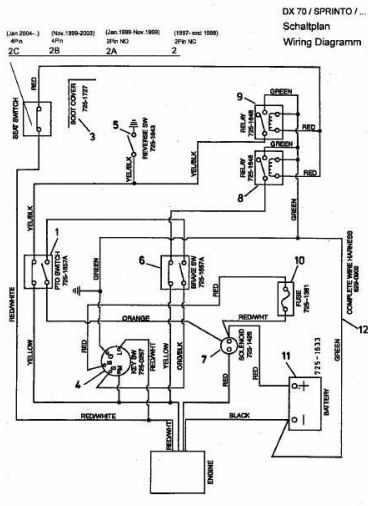

E4-00736B