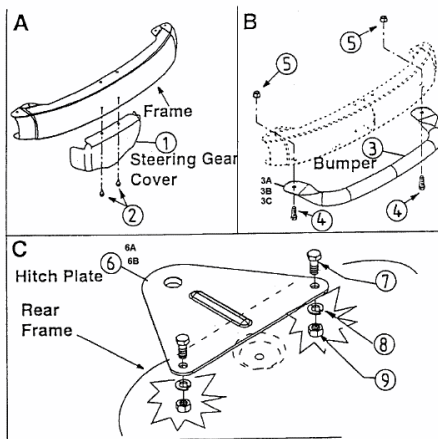

SPRINTO > 13A-312-678 (2002) > ANHÄNGEKUPPLUNG,  
LENKUNGSSCHUTZ, STOSSSTANGE

Optional for Series 325-328

E3-01356 A