

HDS 2205 > 13A-2D7-603 (2005) > GETRIEBE, HYDROSTAT

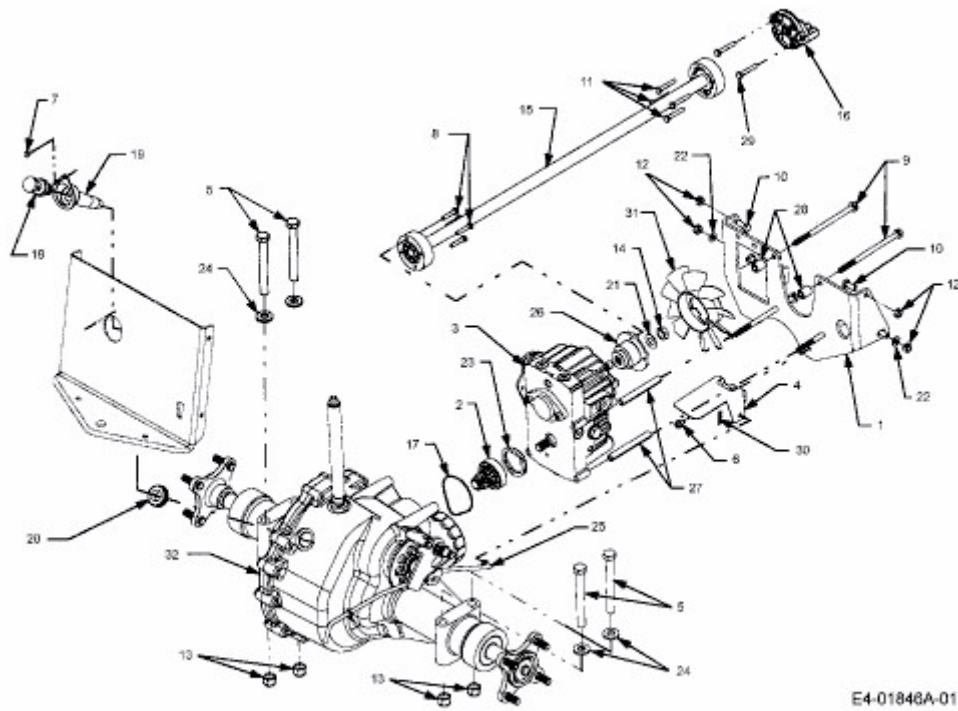

E4-01848A-01