

ab 11.12.2002
from 11.12.2002
à partir du 11.12.2002

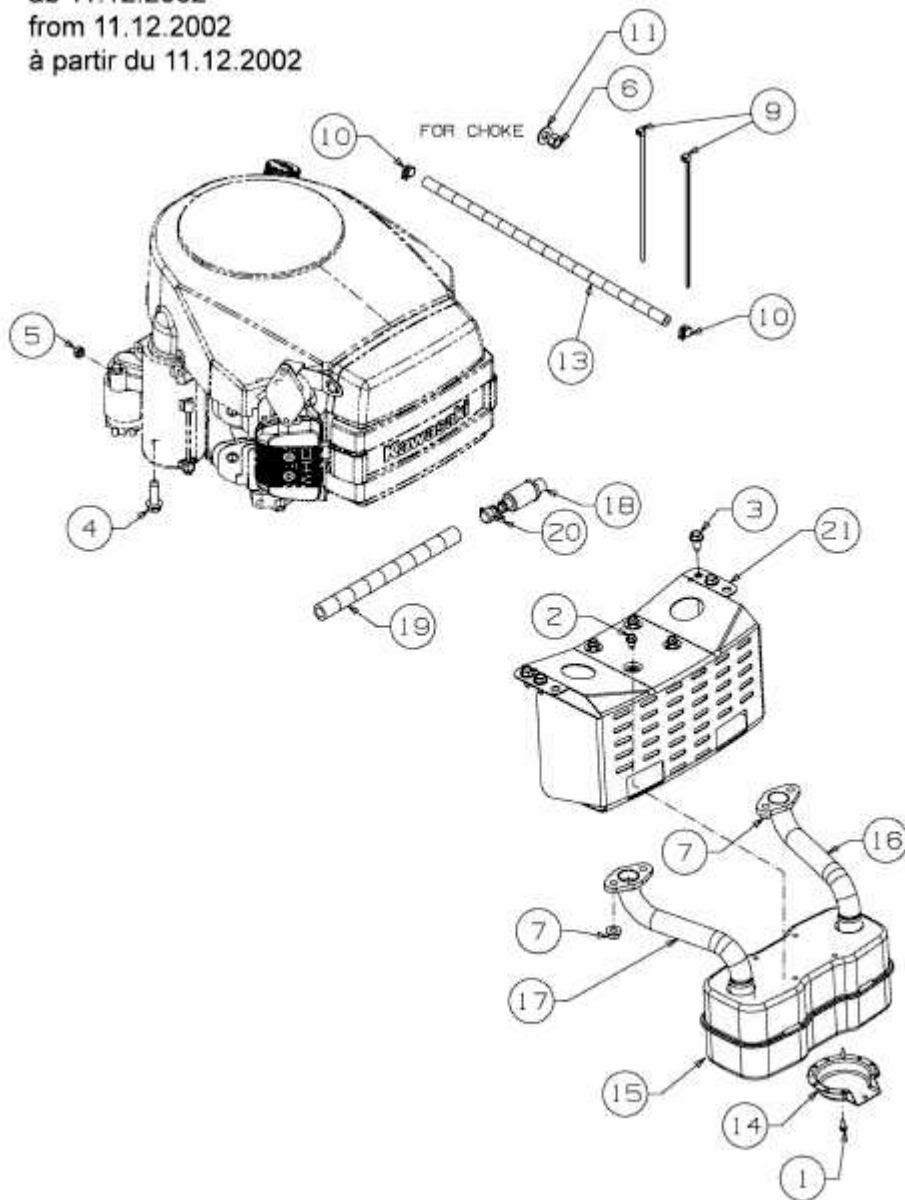

E4-02282A-01