

46 SPOE > 12EEJ5M4600 (2013) > GRASFANGSACK, HECKKLAPPE

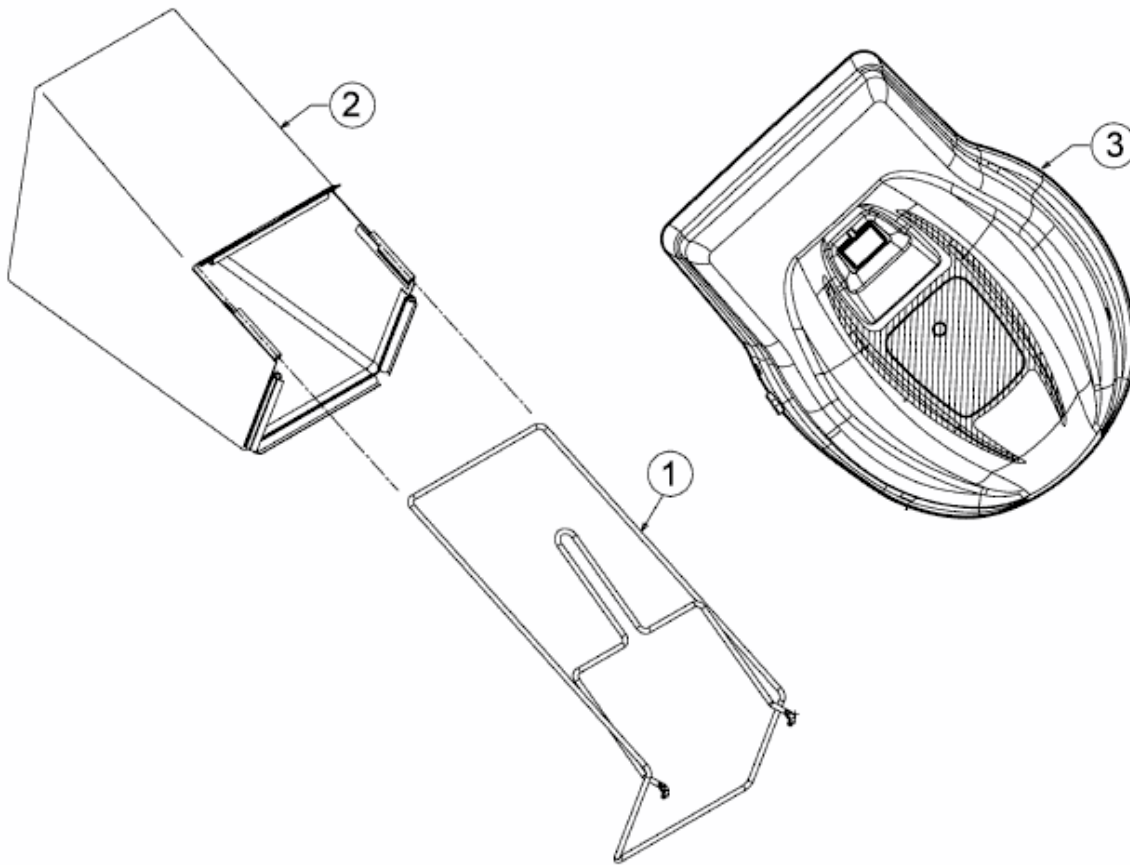

E3-05481A-01