

46 SPOE > 12EEJ5M4600 (2013) > GETRIEBE, KEILRIEMEN

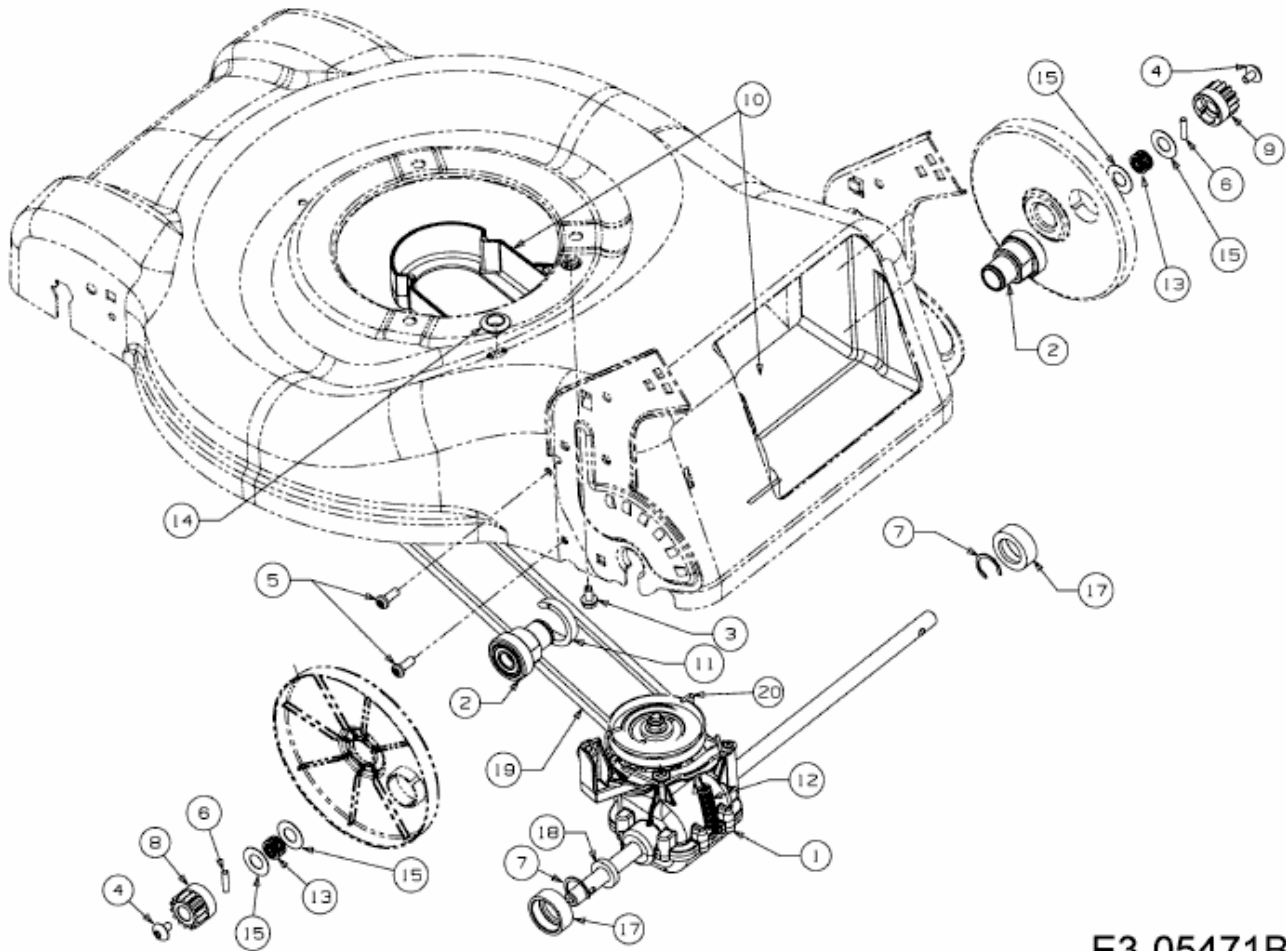

E3-05471B-01