

46 SPBE > 12EEJ58U600 (2009) > SCHNITTHÖHENVERSTELLUNG

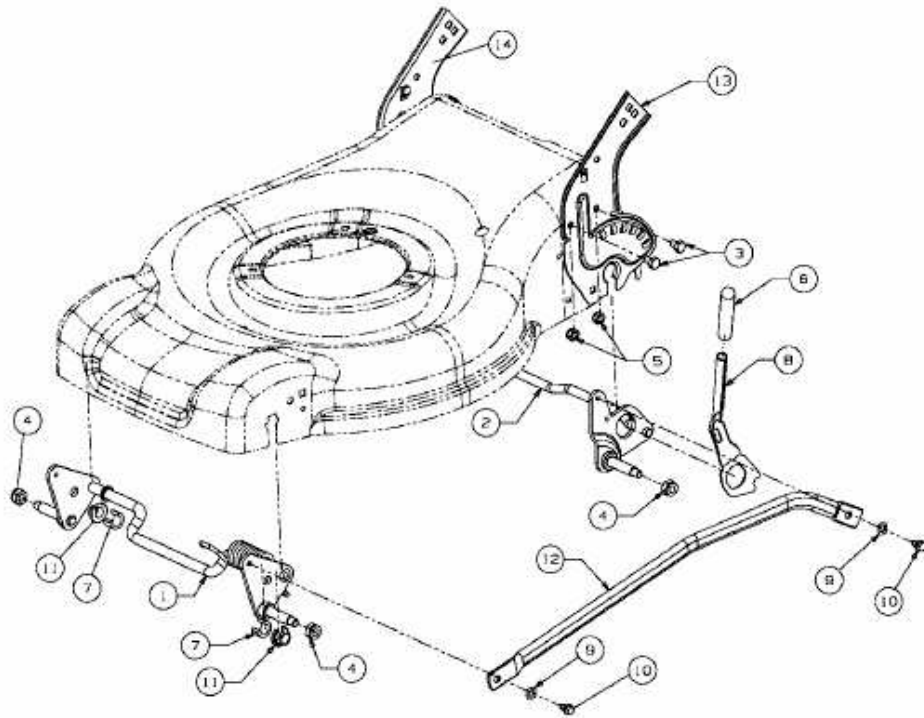

E3-04102A-01