

46 SPO > 12E-J2JD676 (2013) > GRASFANGSACK, HECKKLAPPE

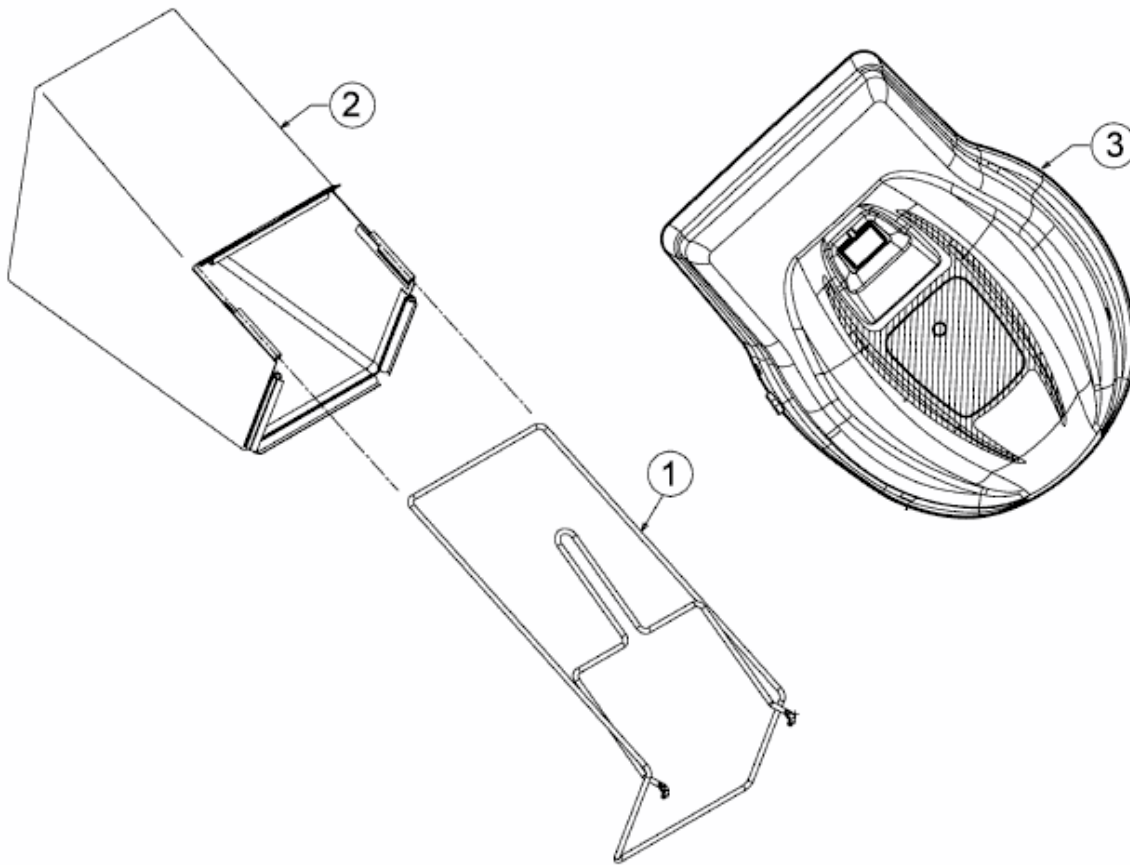

E3-05481A-01