

46 SPO > 12E-J2JD676 (2012) > SCHNITTHÖHENVERSTELLUNG

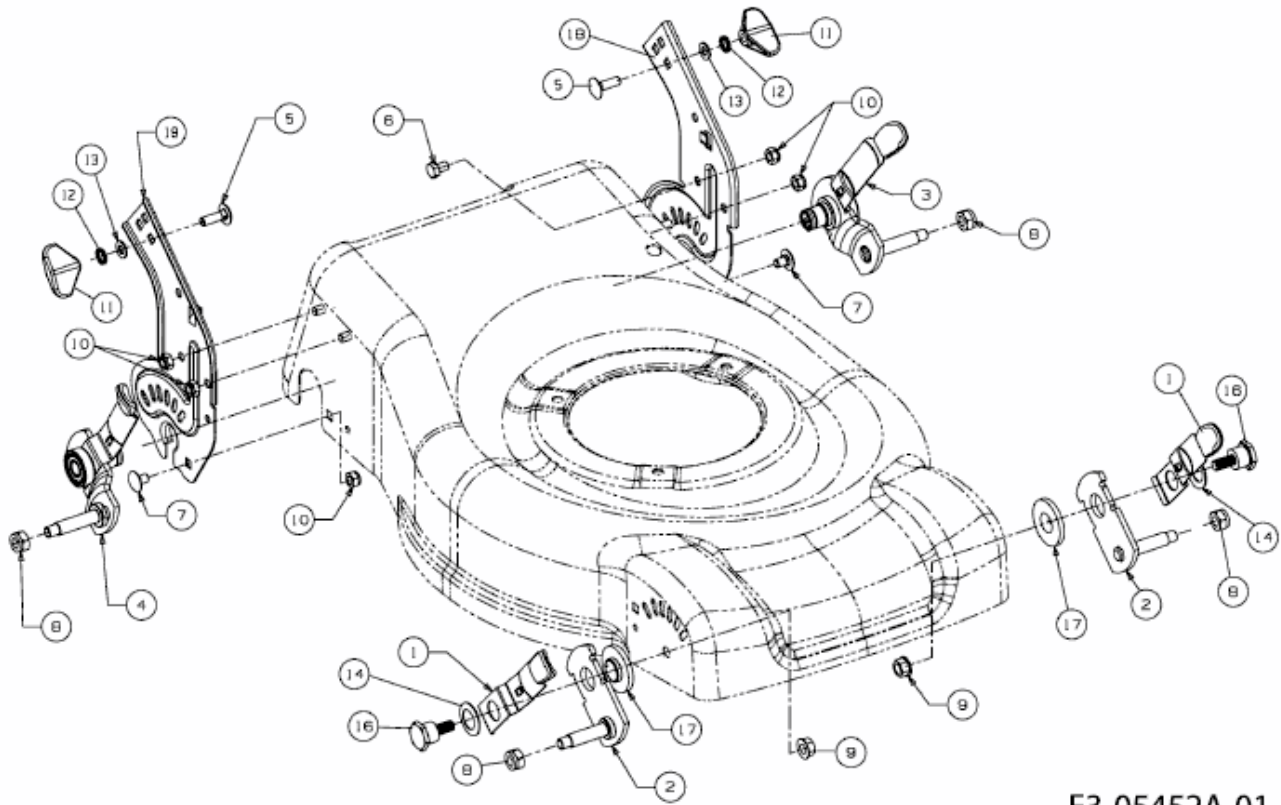

E3-05452A-01