

46 SPO > 12E-J2JD600 (2013) > DECK

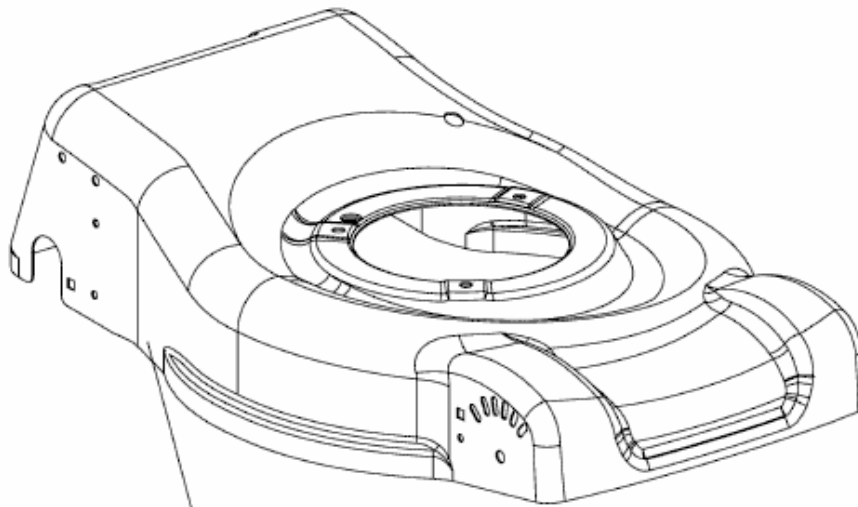

1	46 SPHM, 46 SPO, 46 SPOE, PF 46 A, 46 SPB 46 SPB-4
2	BBM 46-1 R OHV
3	
4	SELECT 4600 A (bis / till 15.11.2011), SELECT 4600 AB
4A	SELECT 4600 A (ab / from 16.11.2011)
5	PM 460W OHV
6	
7	
8	46 SPO HQ, 46 SPHM-HQ, SP 46 B
9	
10	M 4645 SP
11	
12	SP 460 BL
13	
14	

E3-06857A-01