

46 SPO > 12E-J2JD600 (2011) > GRASFANGSACK, HECKKLAPPE

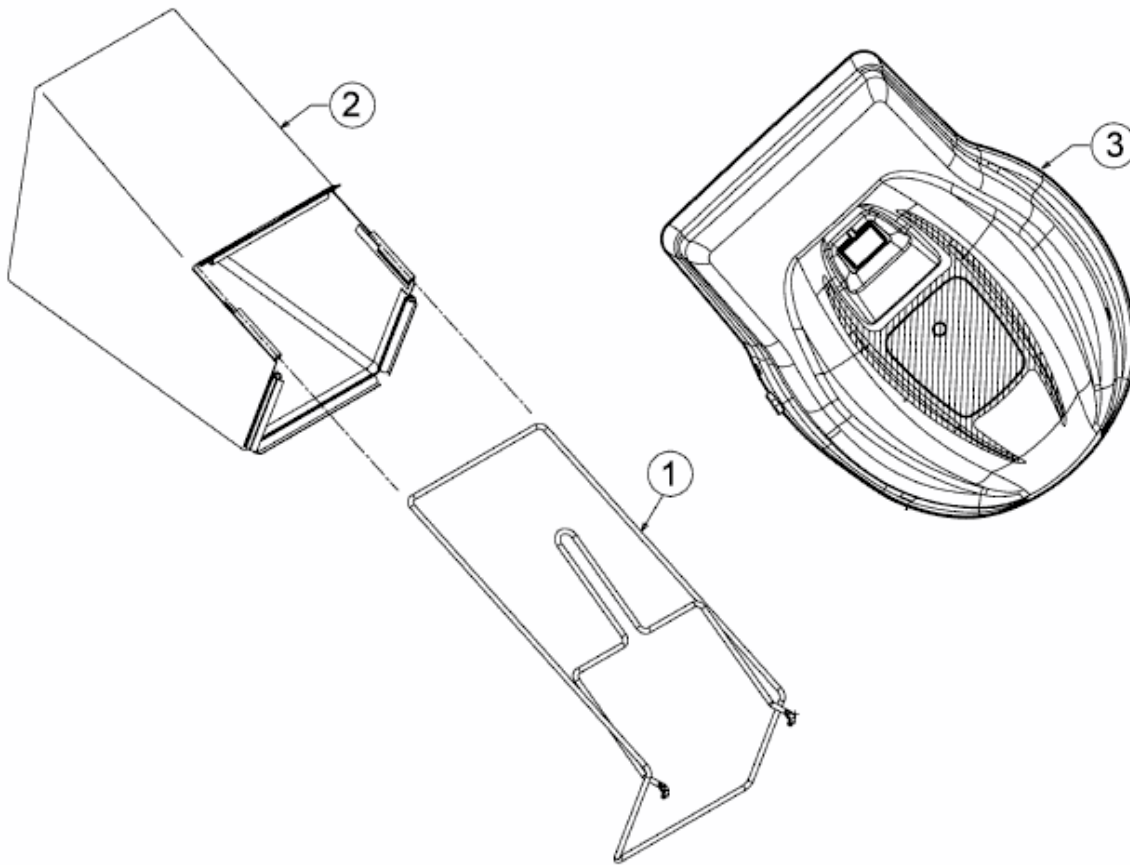

E3-05481A-01