

46 SPO > 12D-J2MD676 (2008) > GETRIEBE, KEILRIEMEN

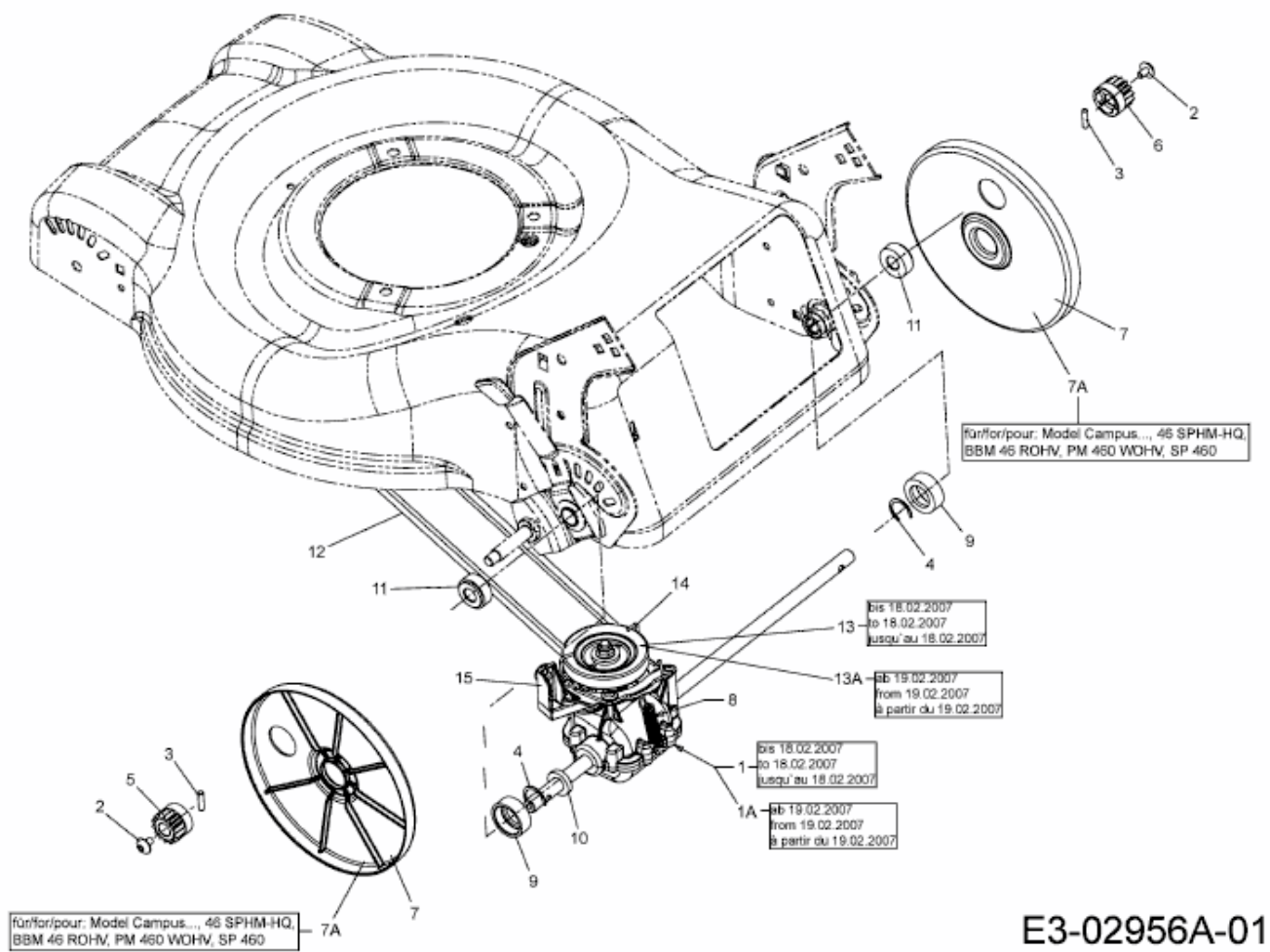

E3-02956A-01