

46 SPO > 12D-J2JD676 (2009) > GETRIEBE, KEILRIEMEN

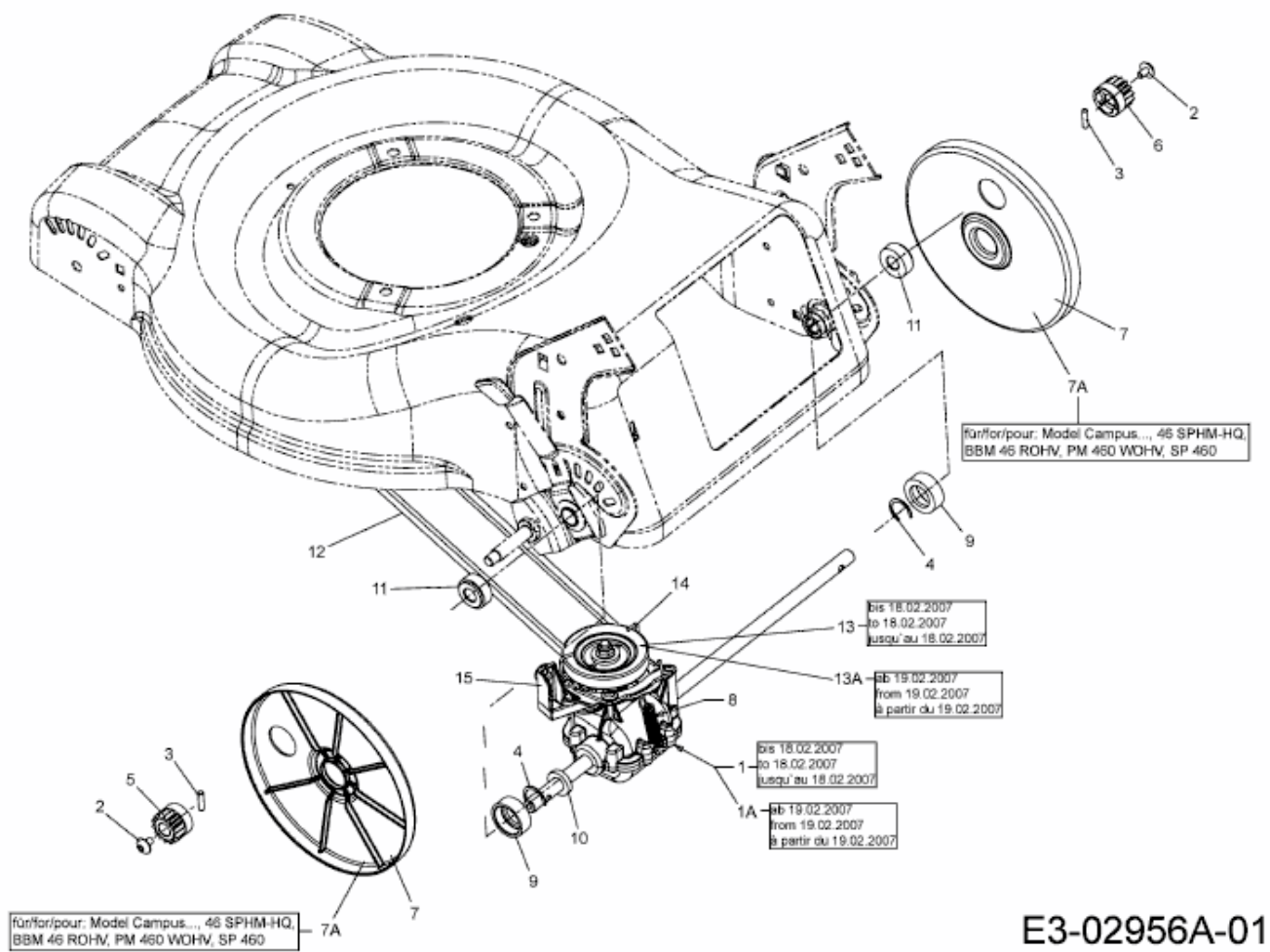

E3-02956A-01