

46 SPM > 12D-J2AQ676 (2011) > MESSER, MESSERAUFNAHME

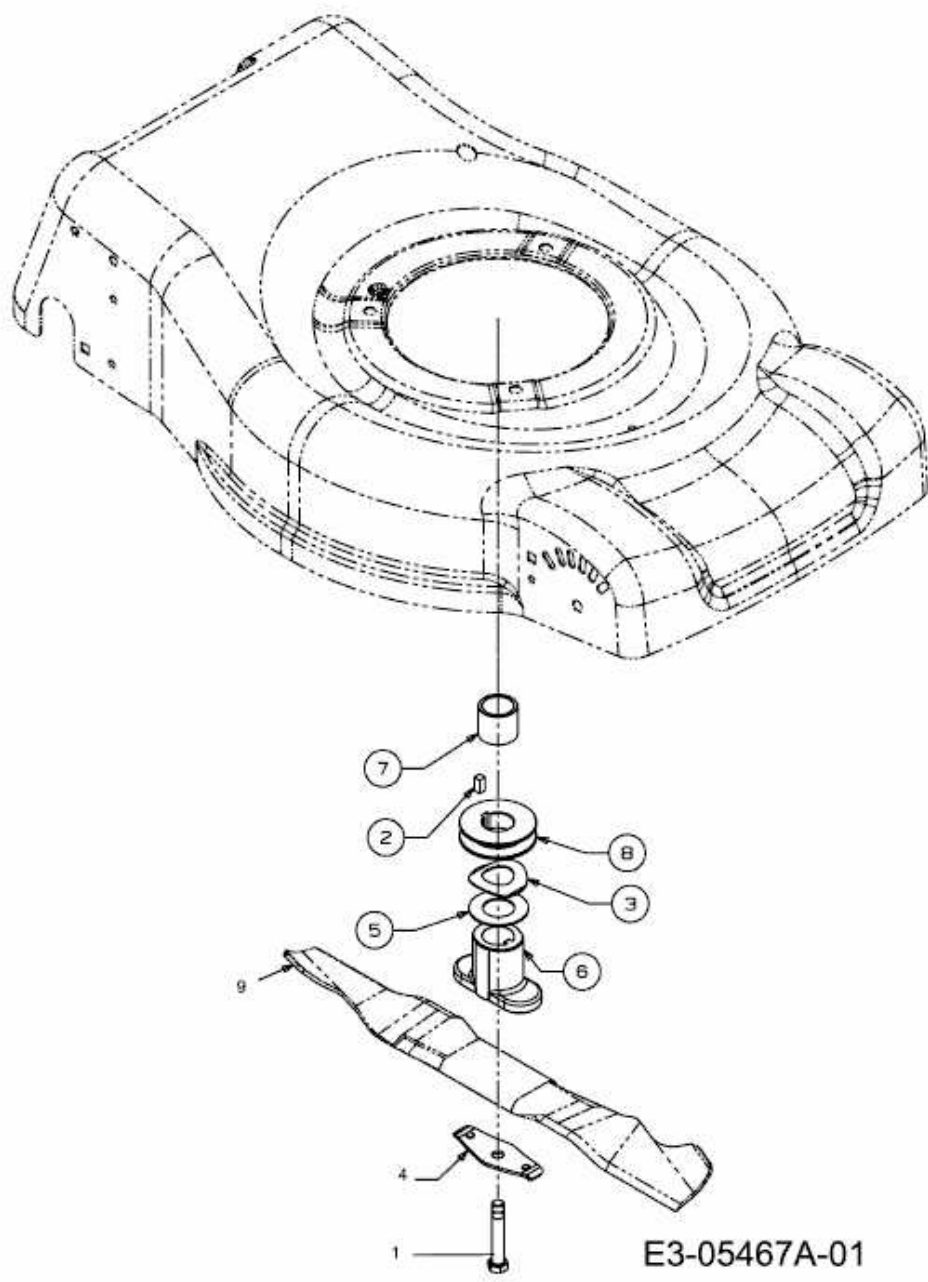

E3-05467A-01