

46 SPHM-HQ > 12D-J2AQ616 (2011) > HOLM

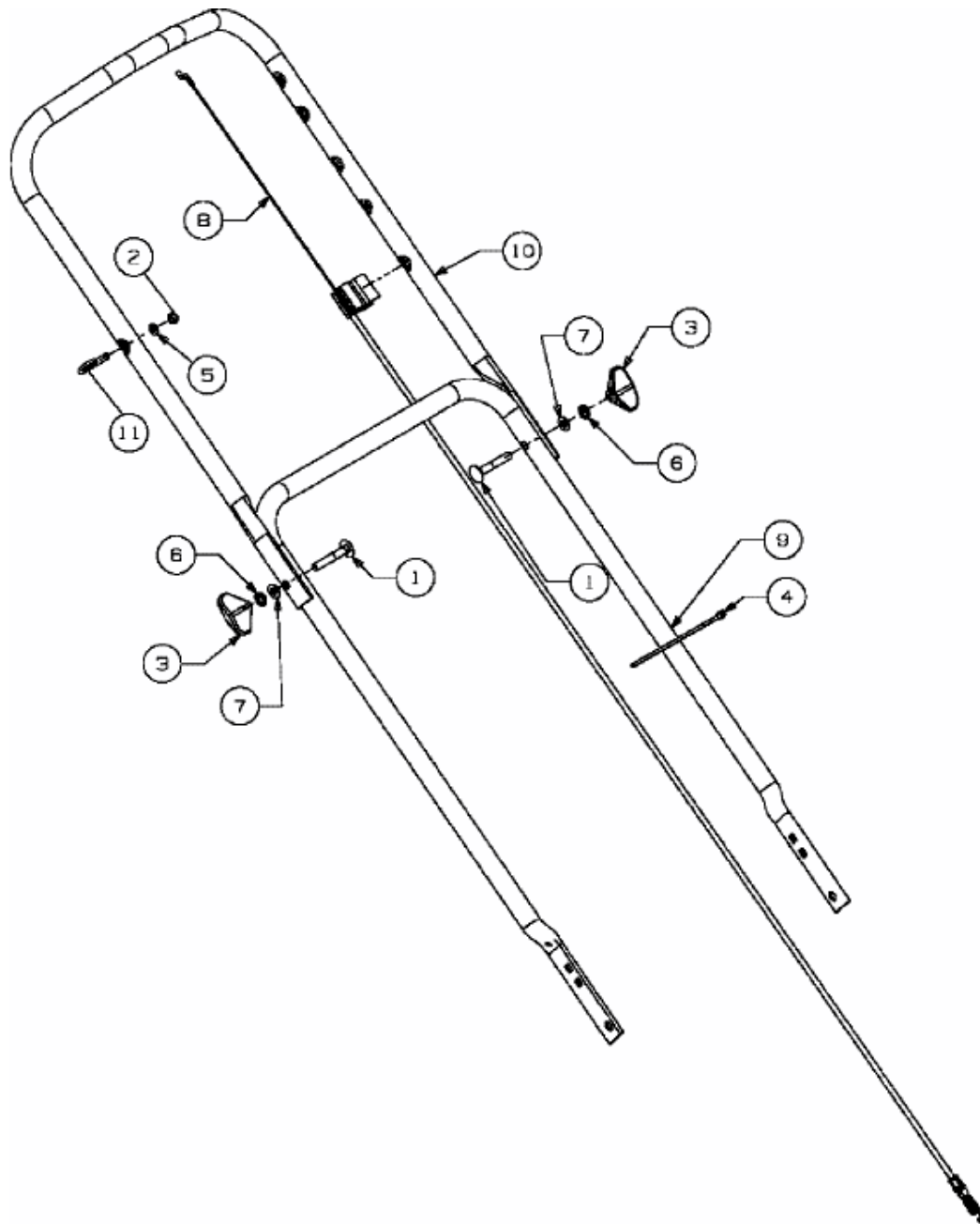

E3-03361A-01