

ab 01.12.2017
from 01.12.2017
à partir du 01.12.2017

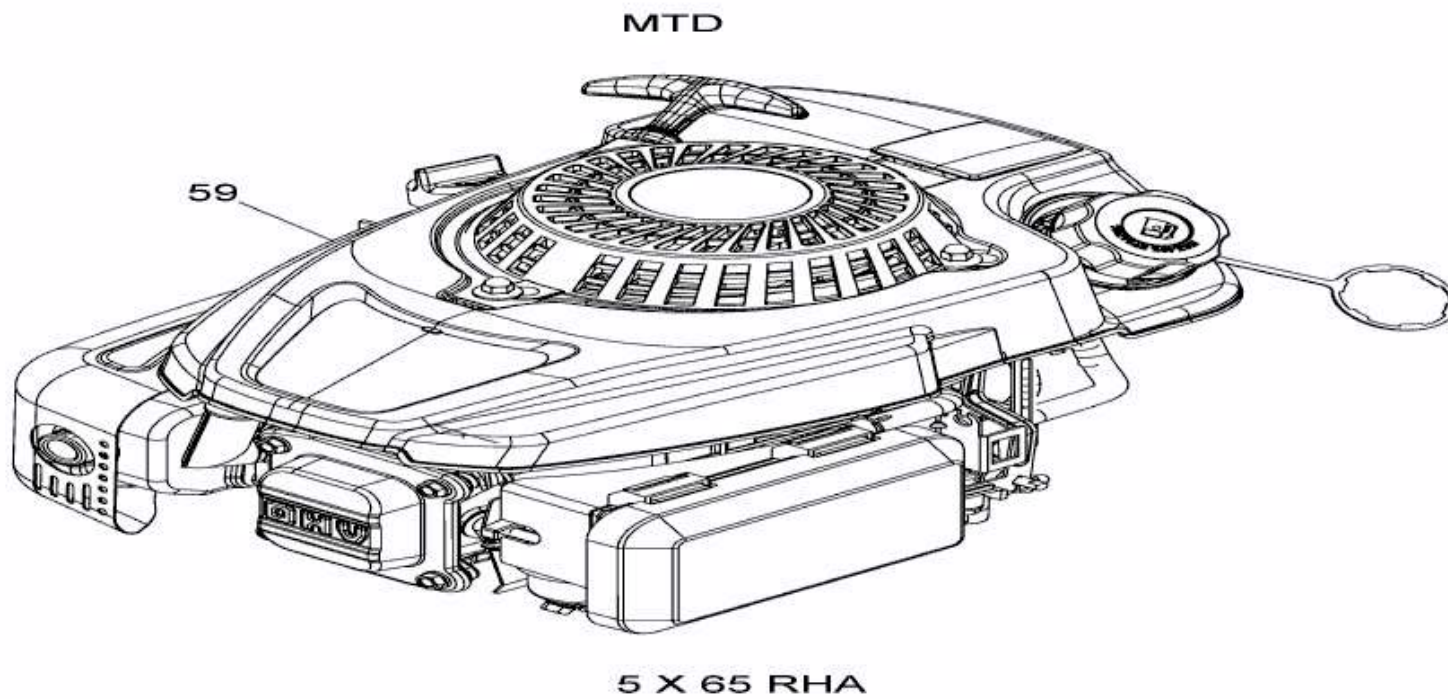

E3-00013A-03