

ab 05/12/2017
effective from 12/05/2017
à partir du 05/12/2017

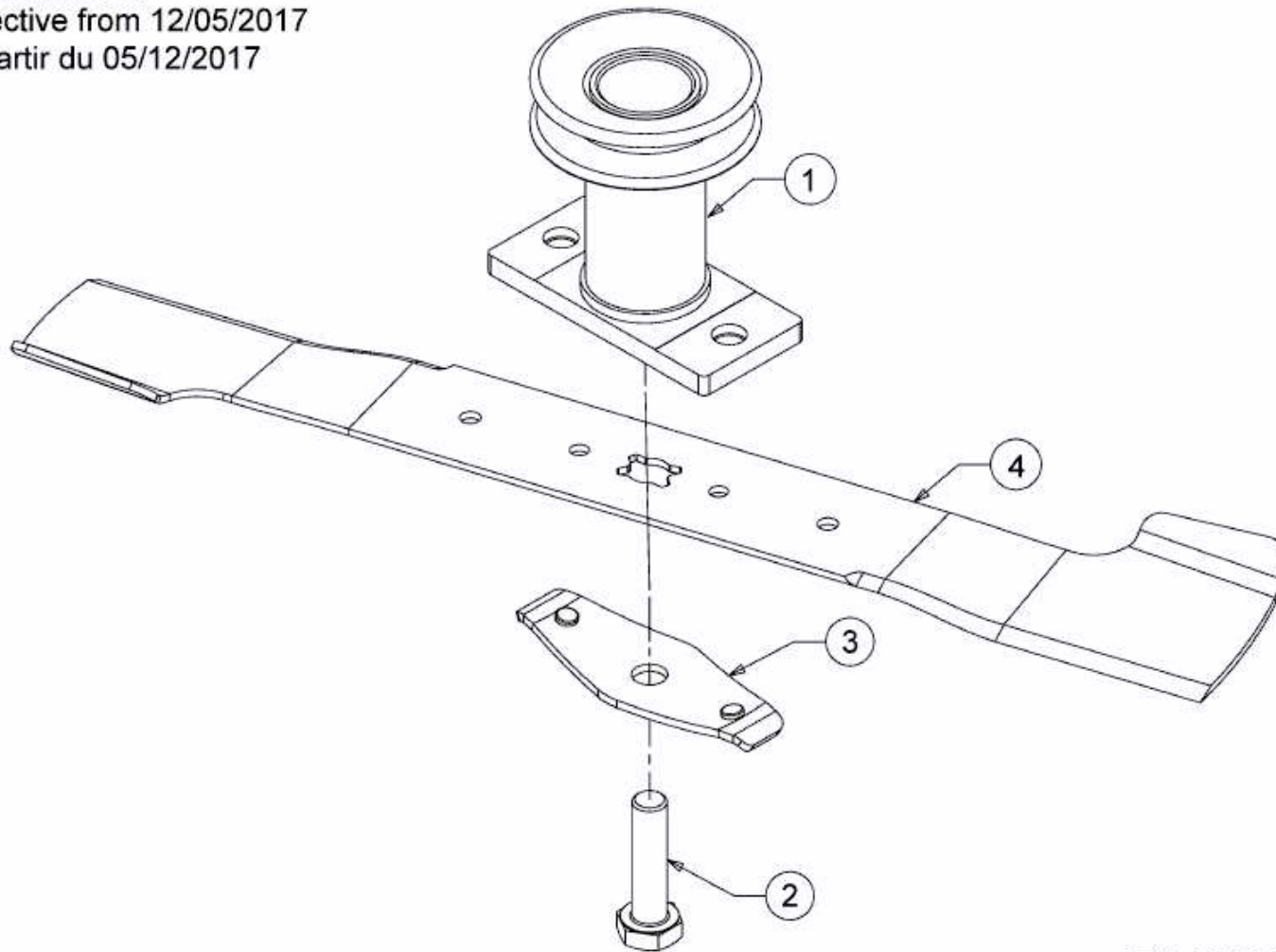

E3-00089A-02