

bis 02/04/2018
til 04/02/2018
jusqu'au 02/04/2018

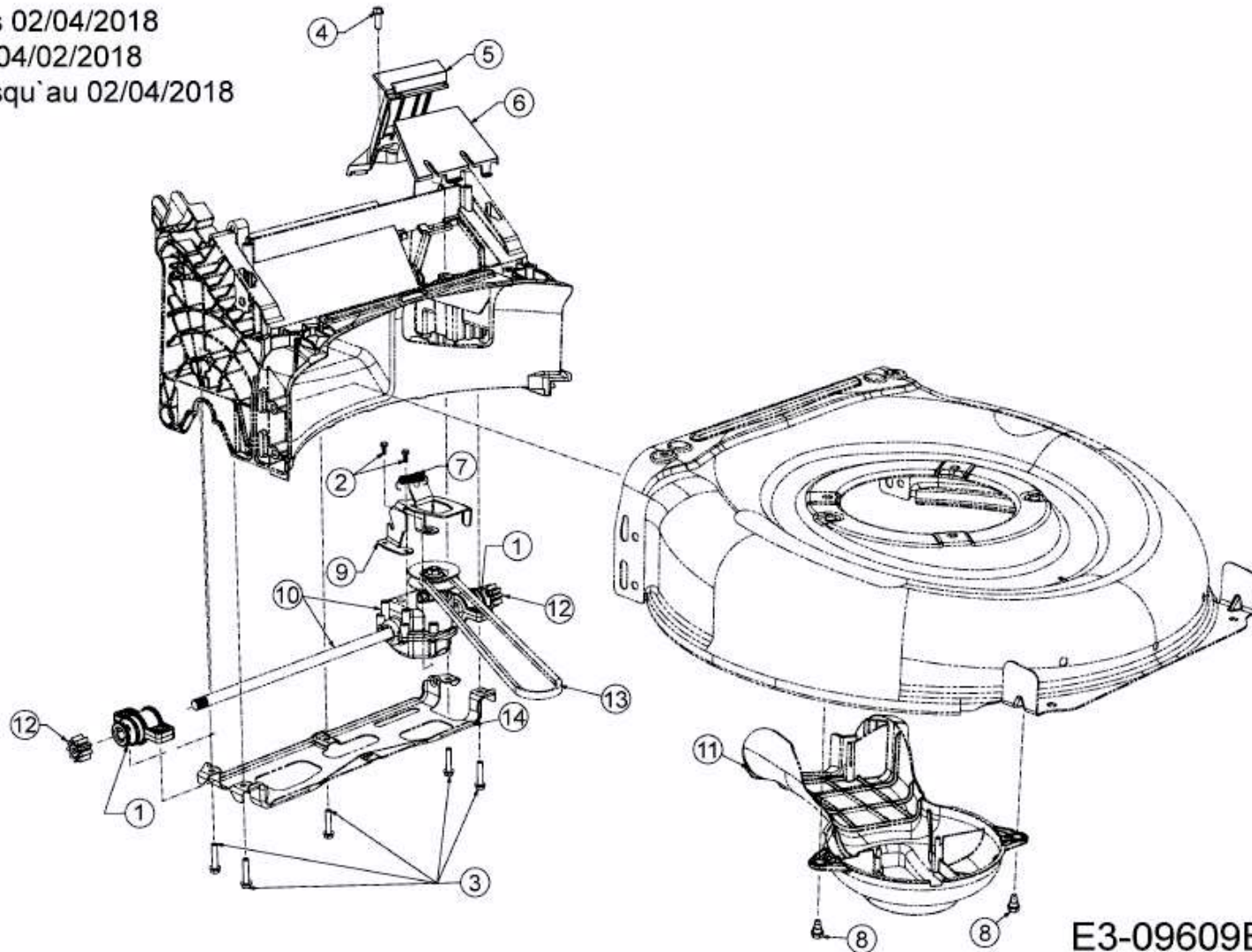

E3-09609B-02