

bis 04/12/2017
until 12/04/2017
jusqu'au 04/12/2017

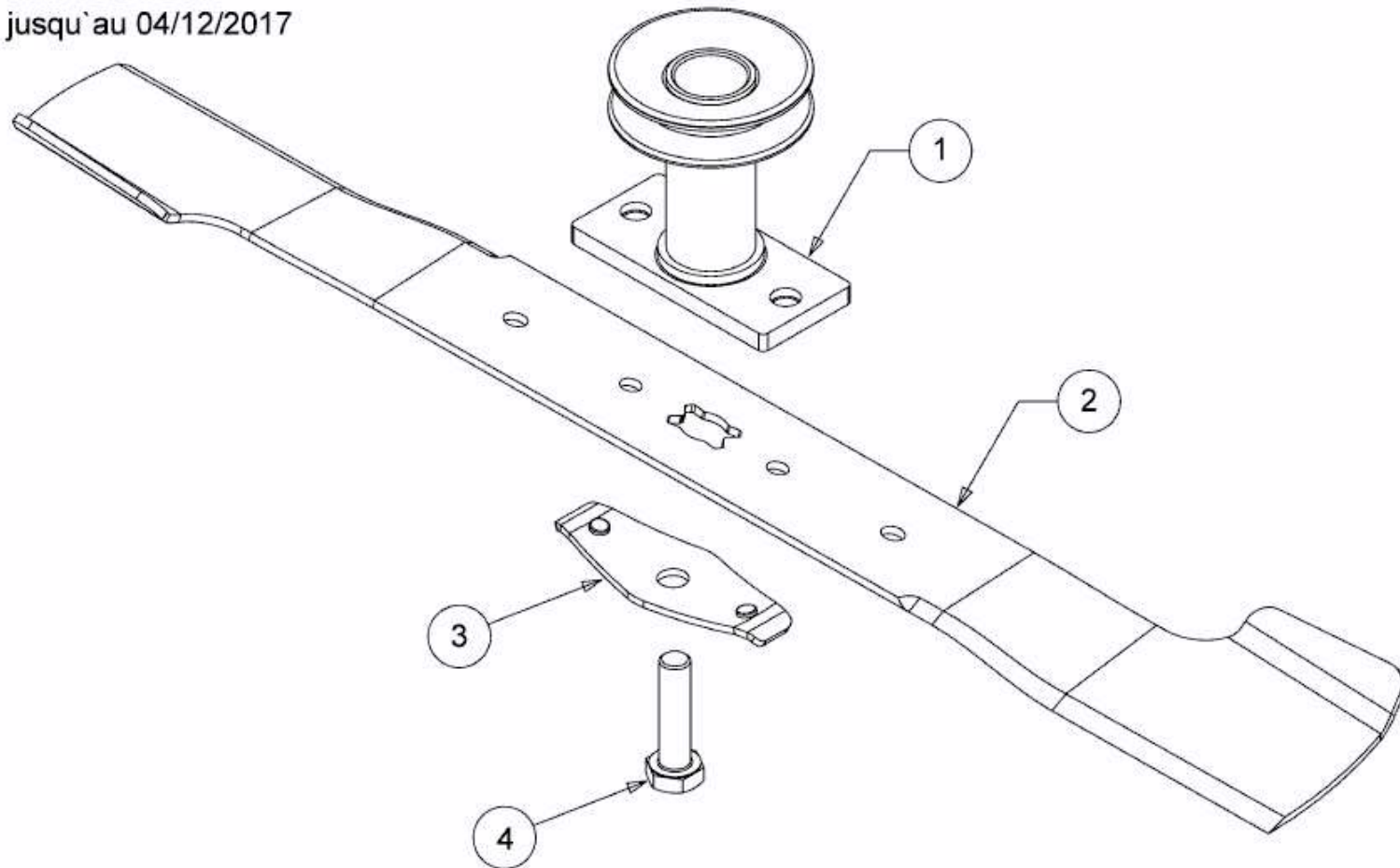

E3-08254B-04