

FBM 46 RH-OHV > 12C-J6M2619 (2012) > SCHNITTHÖHENVERSTELLUNG

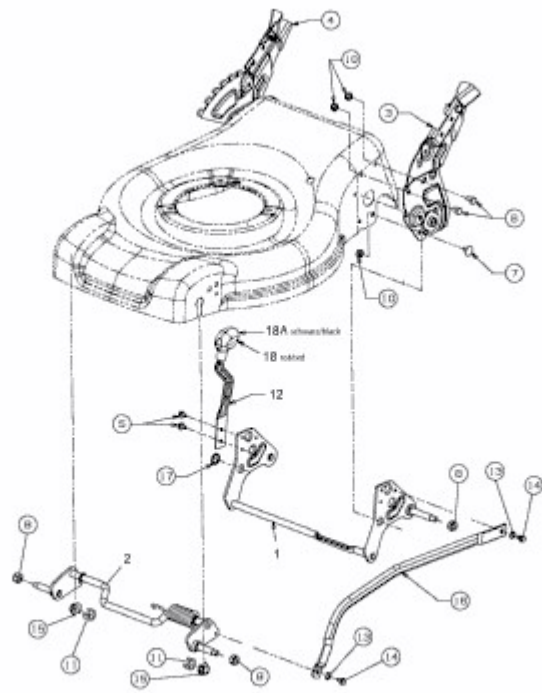

E3-05454B-01