

46 SPKHW > 12C-J67D600 (2013) > SCHNITTHÖHENVERSTELLUNG

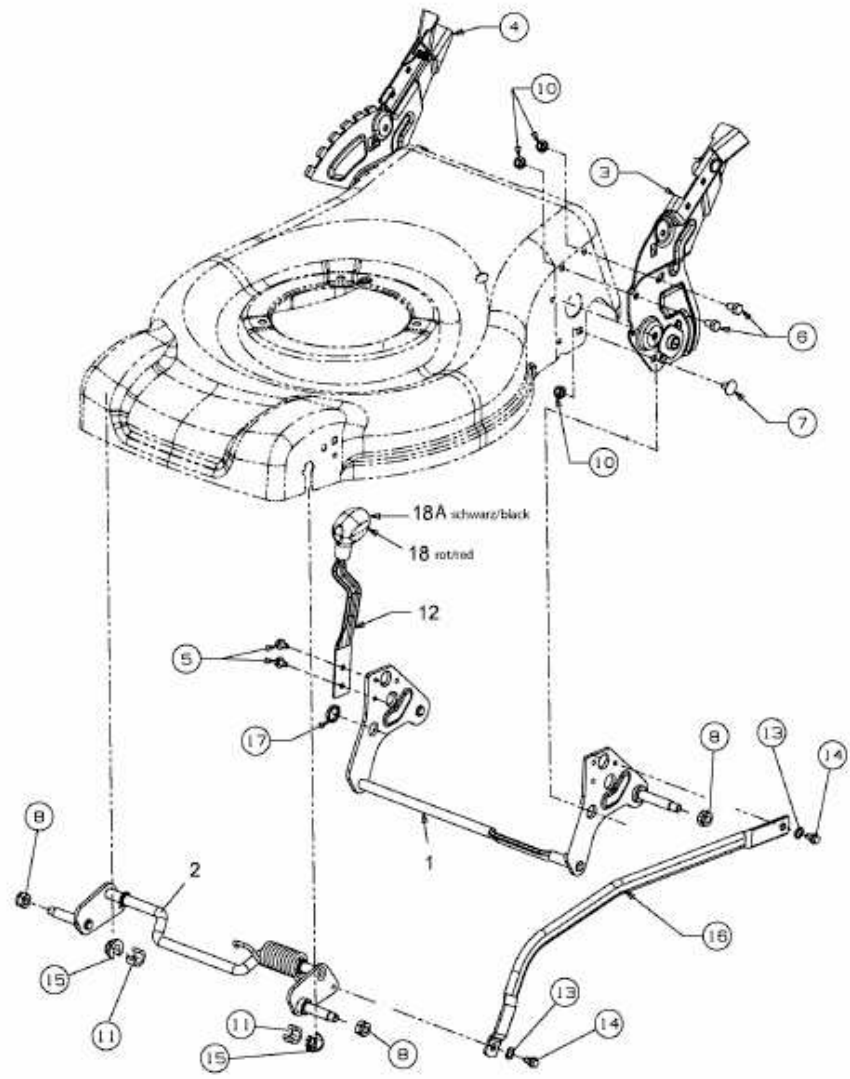

E3-05454B-01