

SP 460 > 12C-J2ML659 (2009) > GETRIEBE, KEILRIEMEN

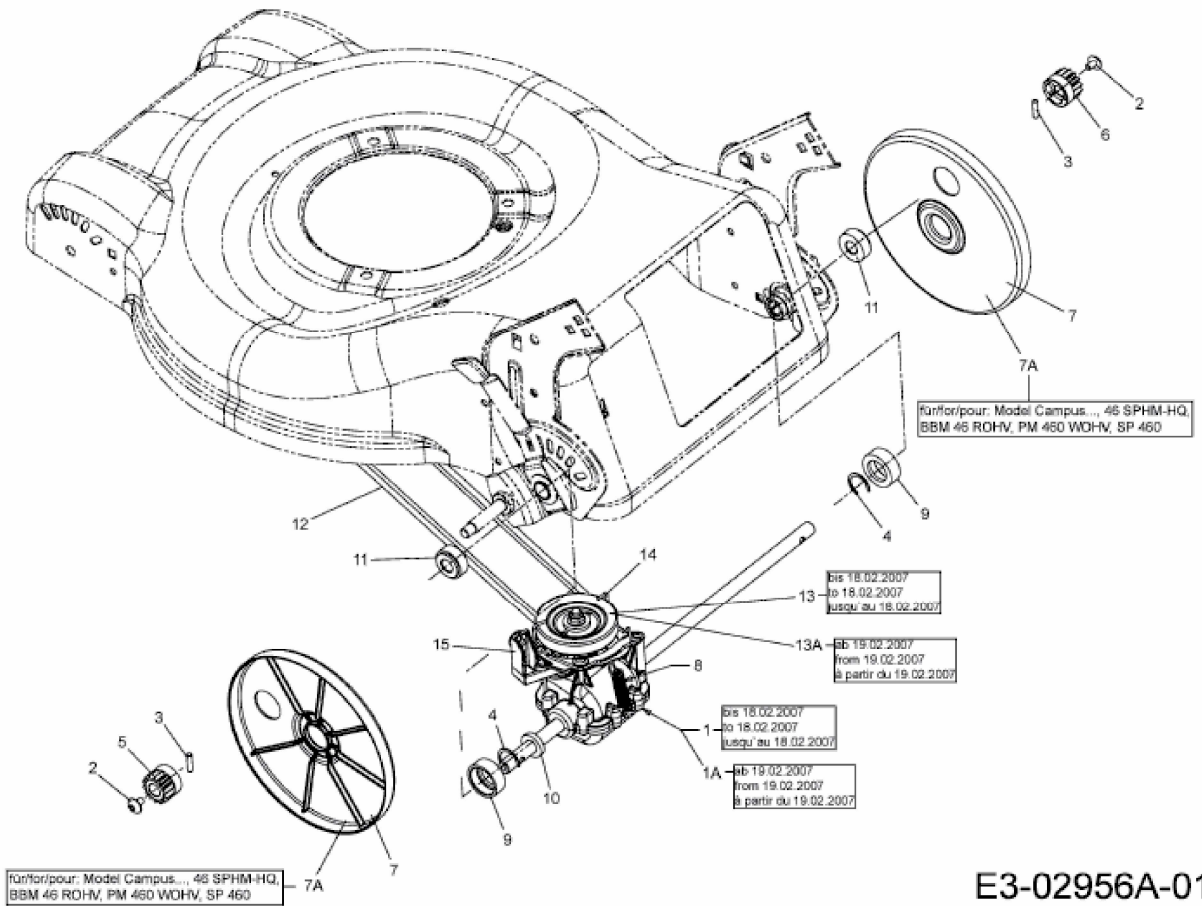

E3-02956A-01