

PM 460 WOHV > 12C-J2MD651 (2007) > GETRIEBE, KEILRIEMEN

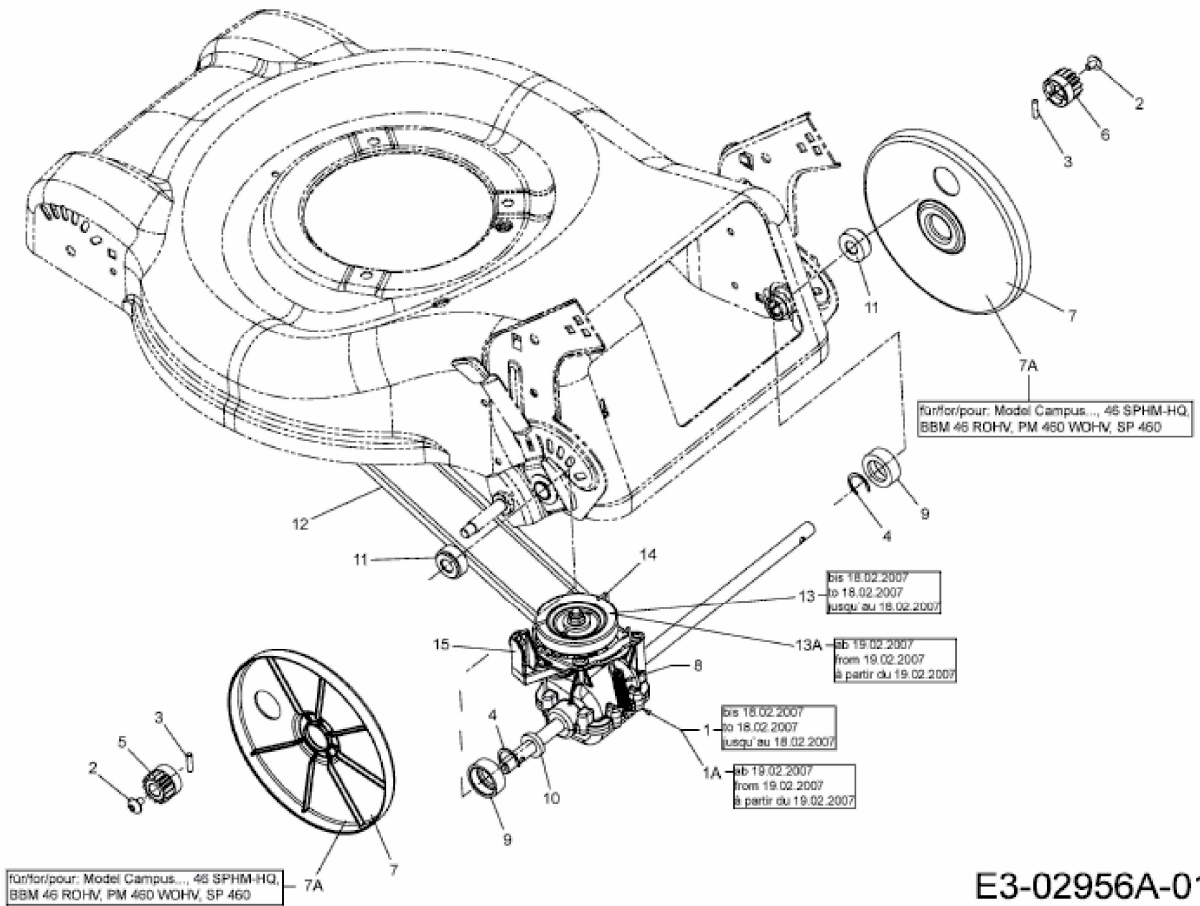

E3-02956A-01