

46 SPO > 12C-J2MD600 (2007) > GETRIEBE, KEILRIEMEN

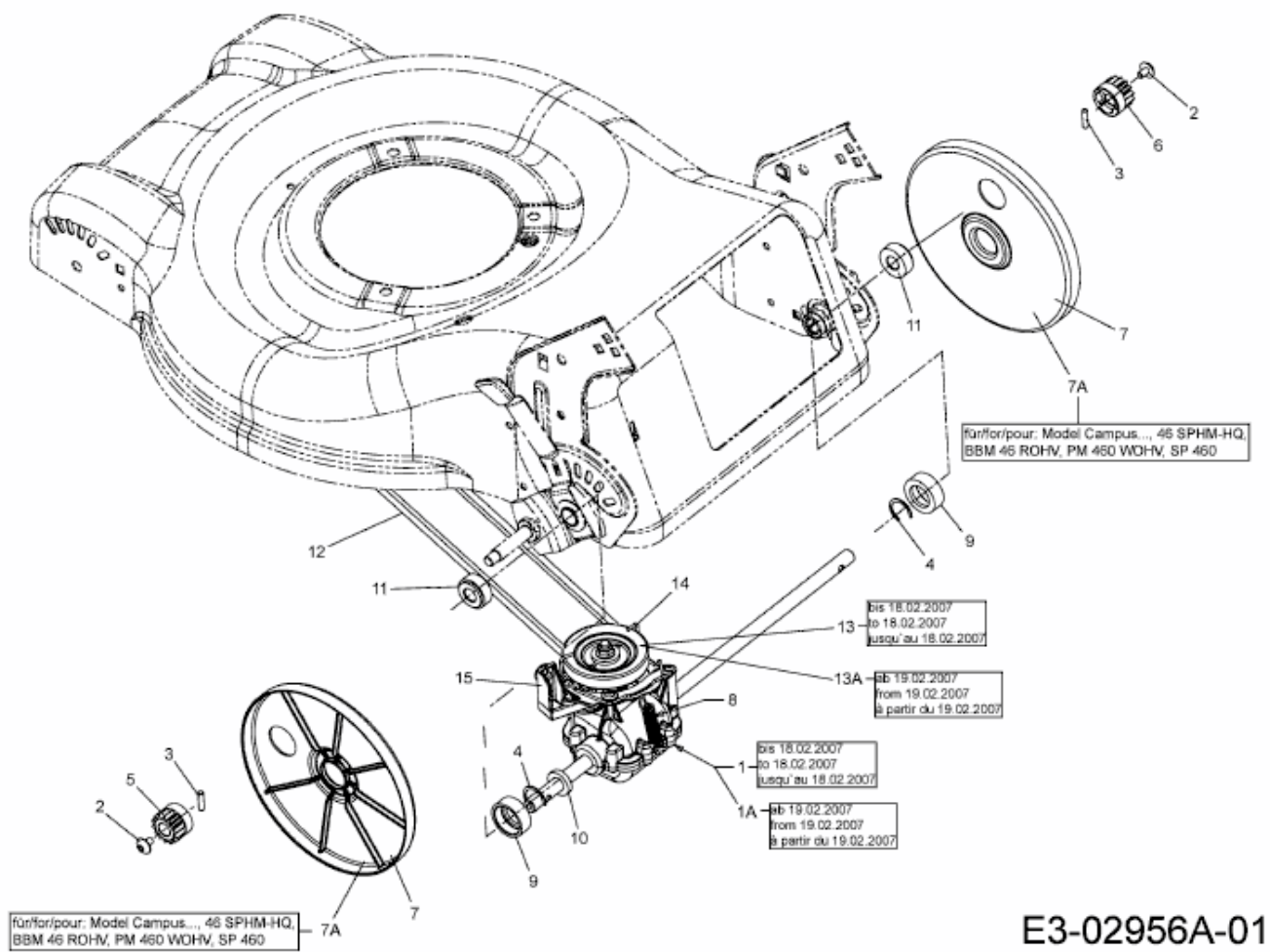

E3-02956A-01