

PM 460 WBS > 12C-J20G651 (2009) > GETRIEBE, KEILRIEMEN

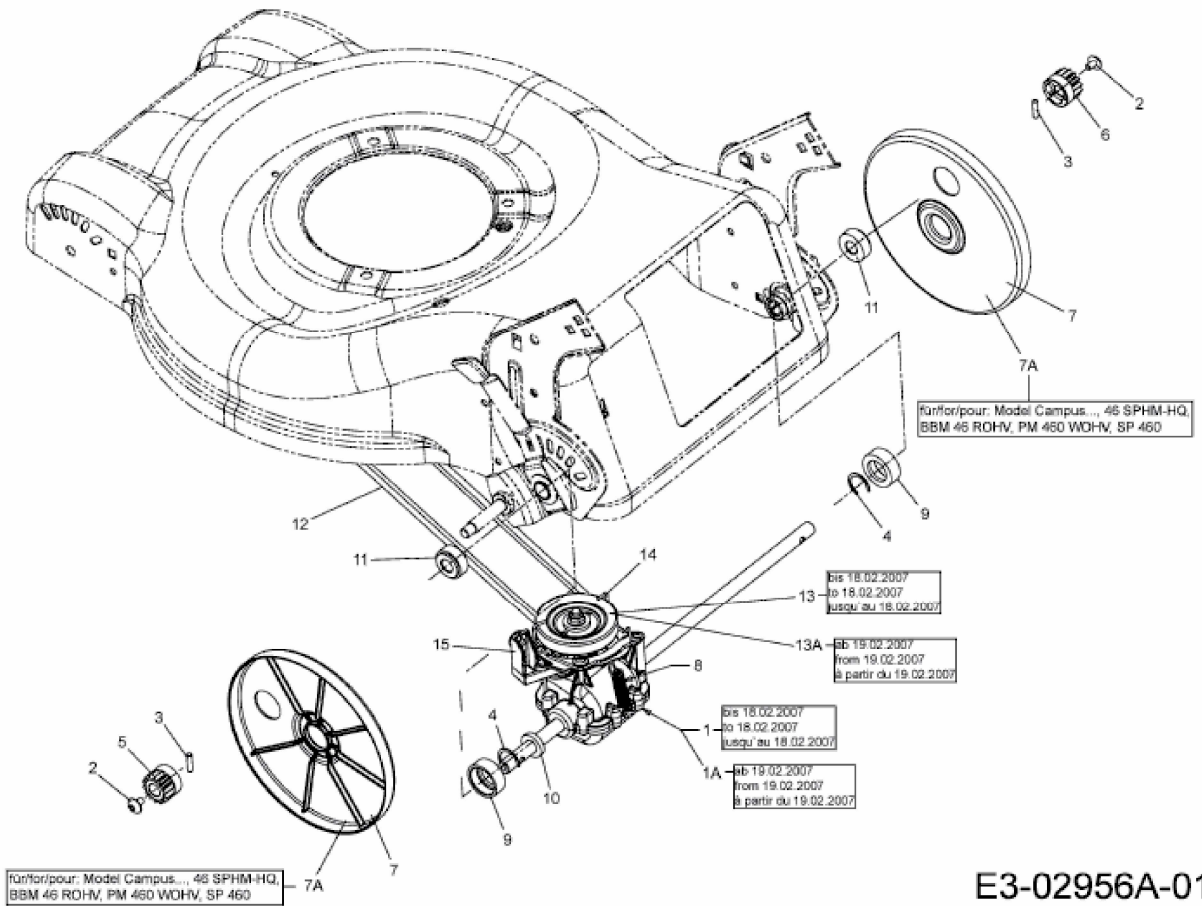

E3-02956A-01