

46 SPB-35 > 12C-J20G600 (2008) > GETRIEBE, KEILRIEMEN

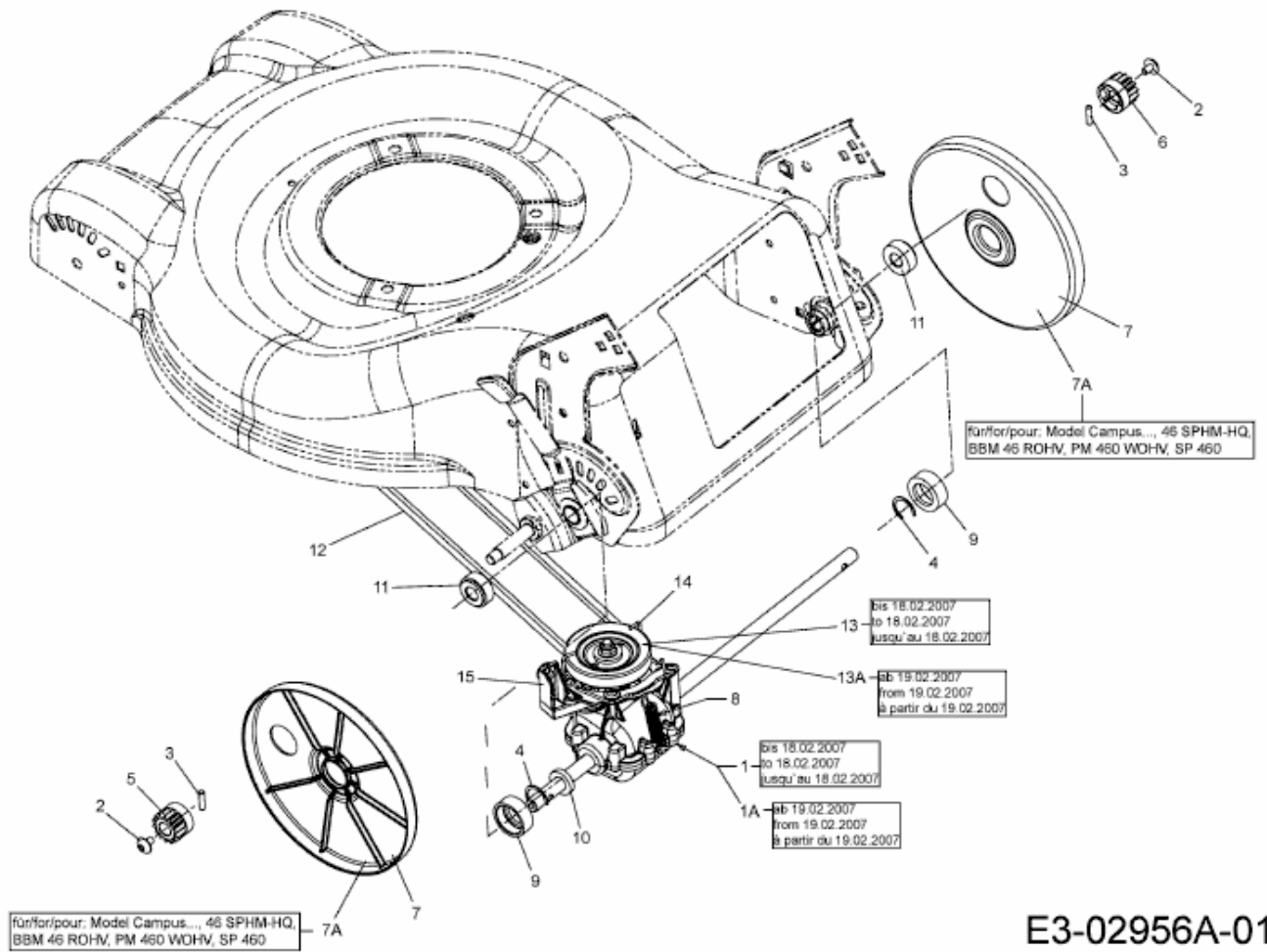

E3-02956A-01