

B 53 HMA > 12C-868F694 (2013) > MULCHSTOPFEN, LEITBLECH VORN

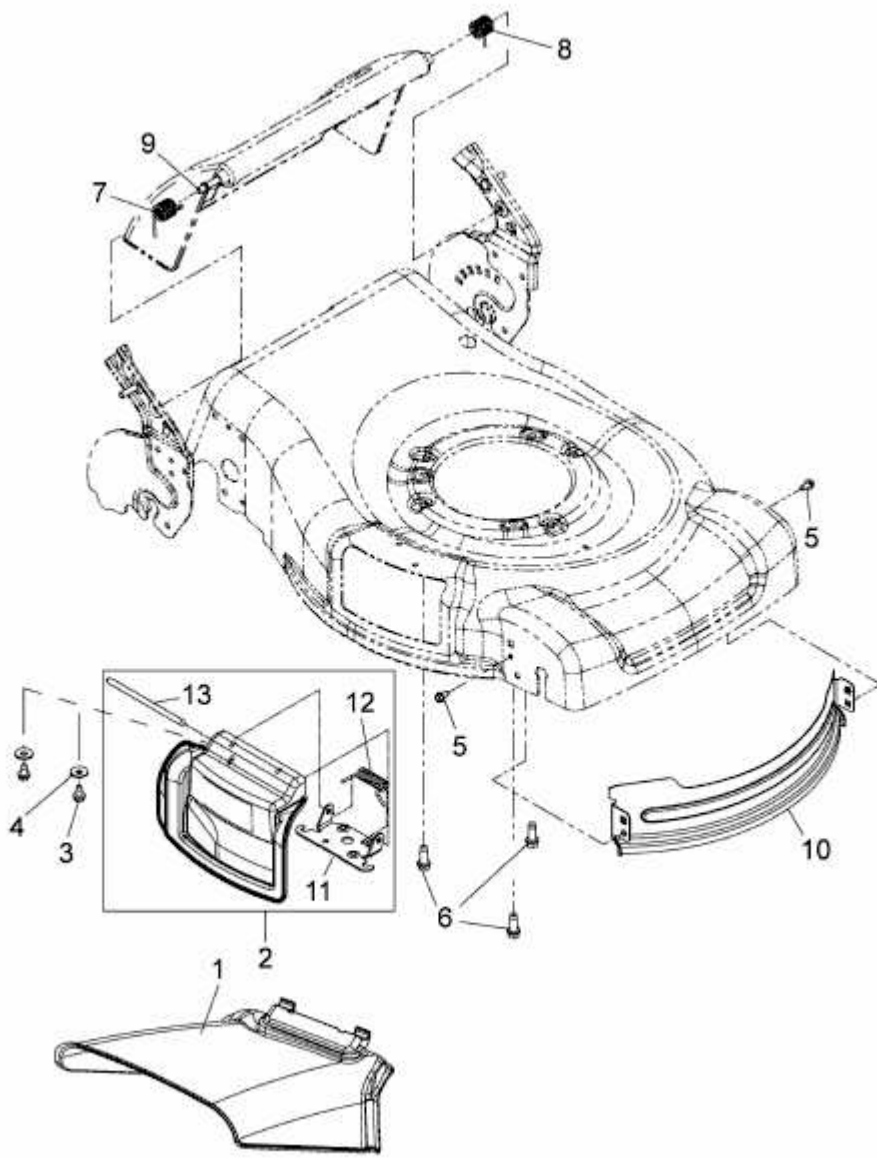

E3-05335A-01