

B 53 HMA > 12C-868F694 (2012) > ABDECKUNG VORDERACHSE

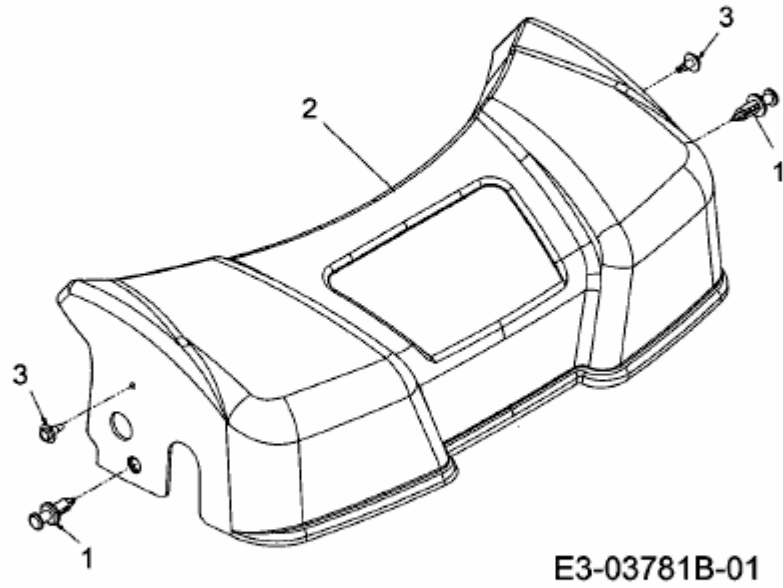

E3-03781B-01