

SELECT 5300 A > 12C-84JT650 (2012) > MÄHWERKSGEHÄUSE, STANGE FÜR HECKKLAPPE

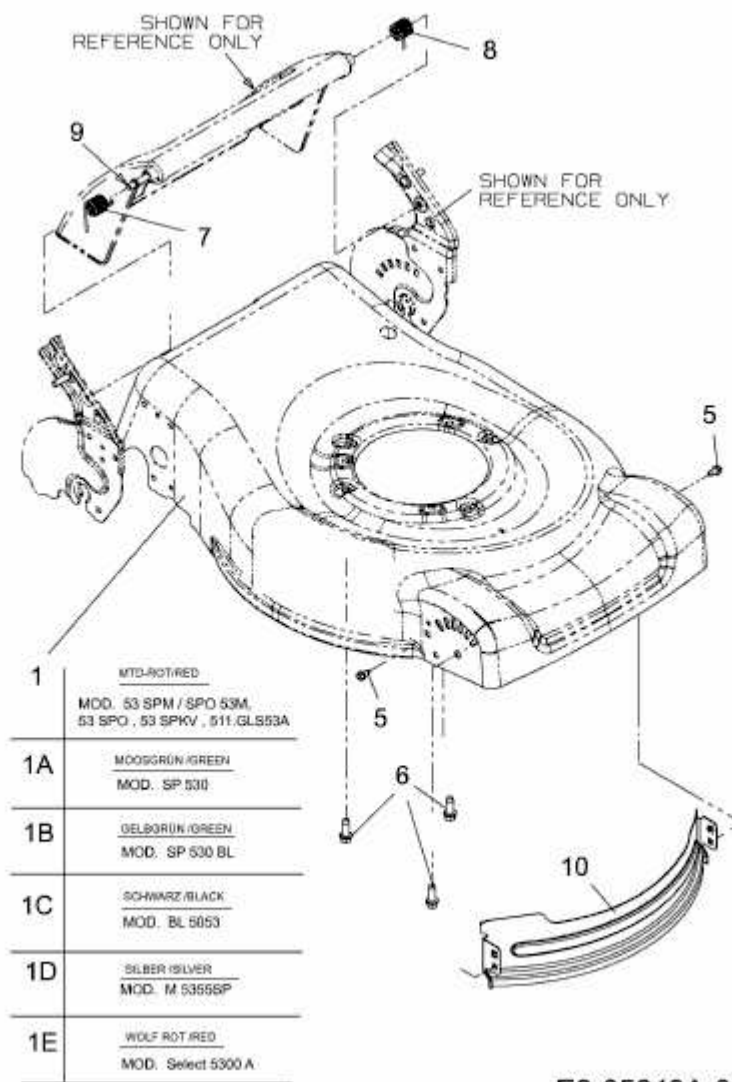

E3-05643A-01