

ab 06.11.2015
from 06.11.2015
à partir du 06.11.2015

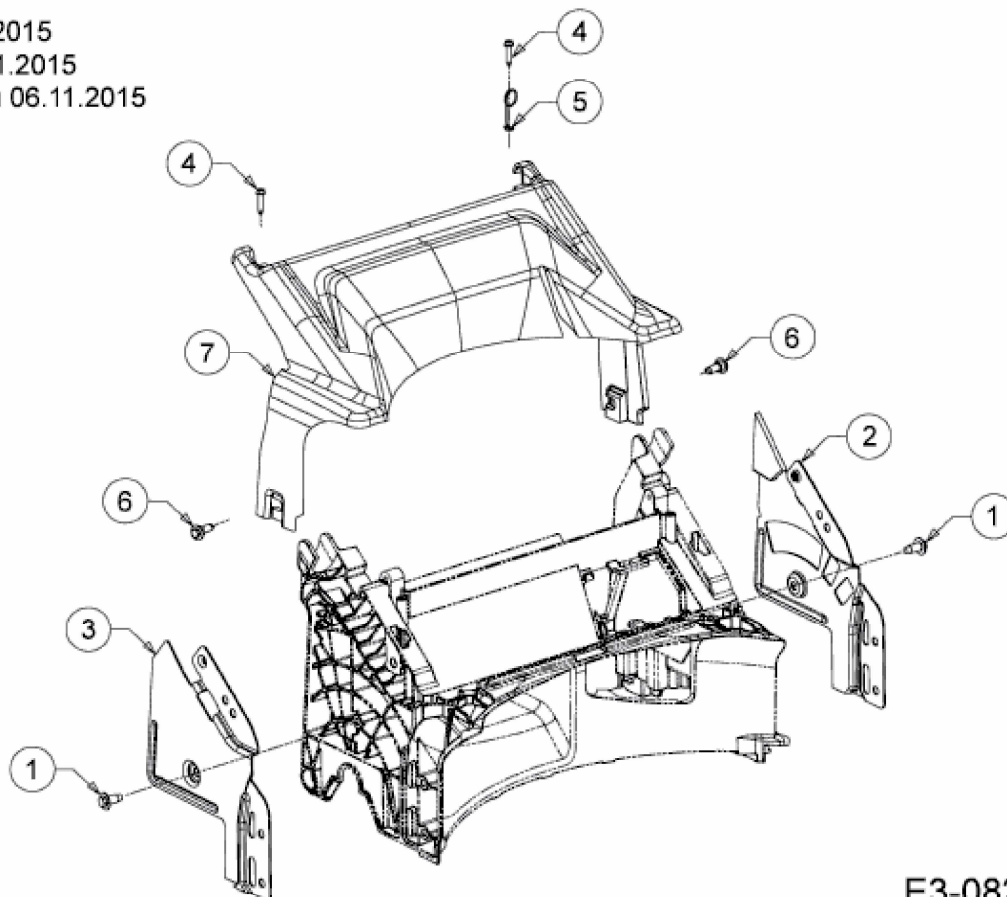

E3-08213B-02