

ab 18.01.2016
from 18.01.2016
à partir du 18.01.2016

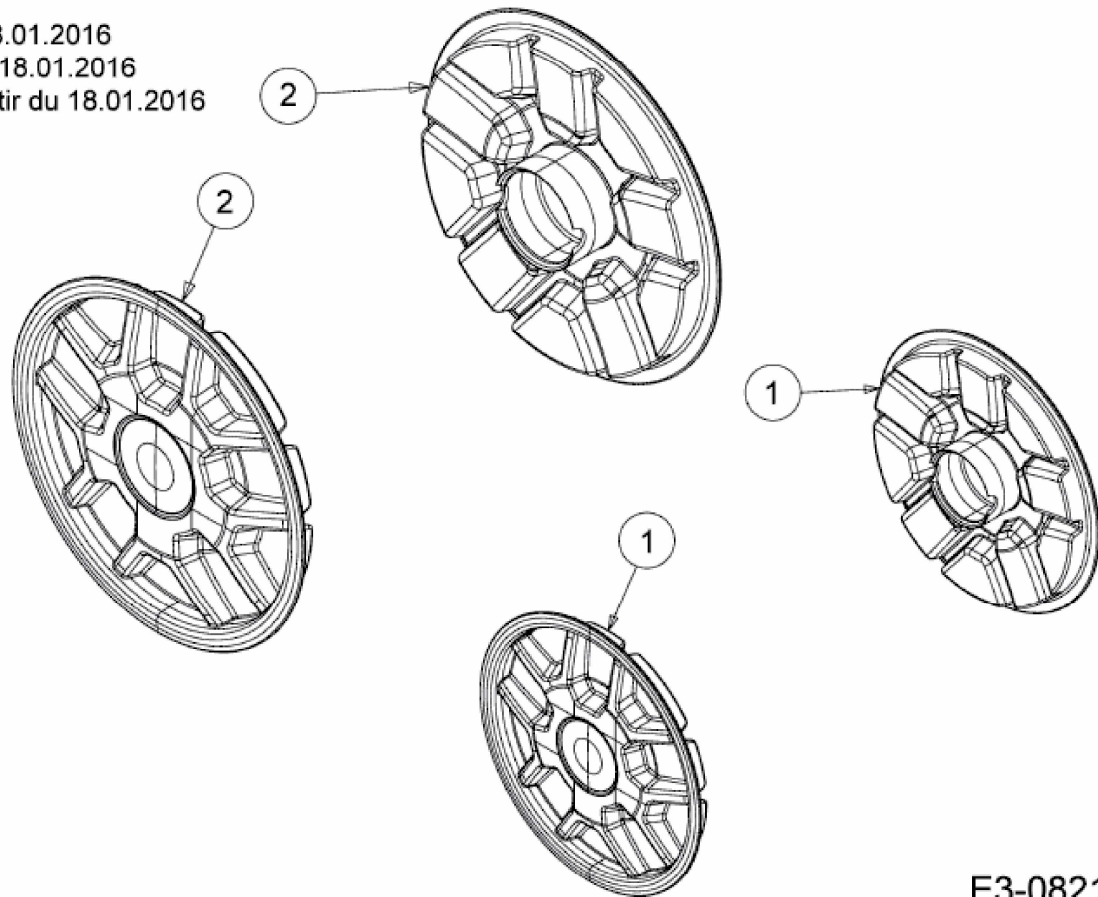

E3-08219A-03