

ab 12.01.2017
from 12.01.2017
à partir du 12.01.2017

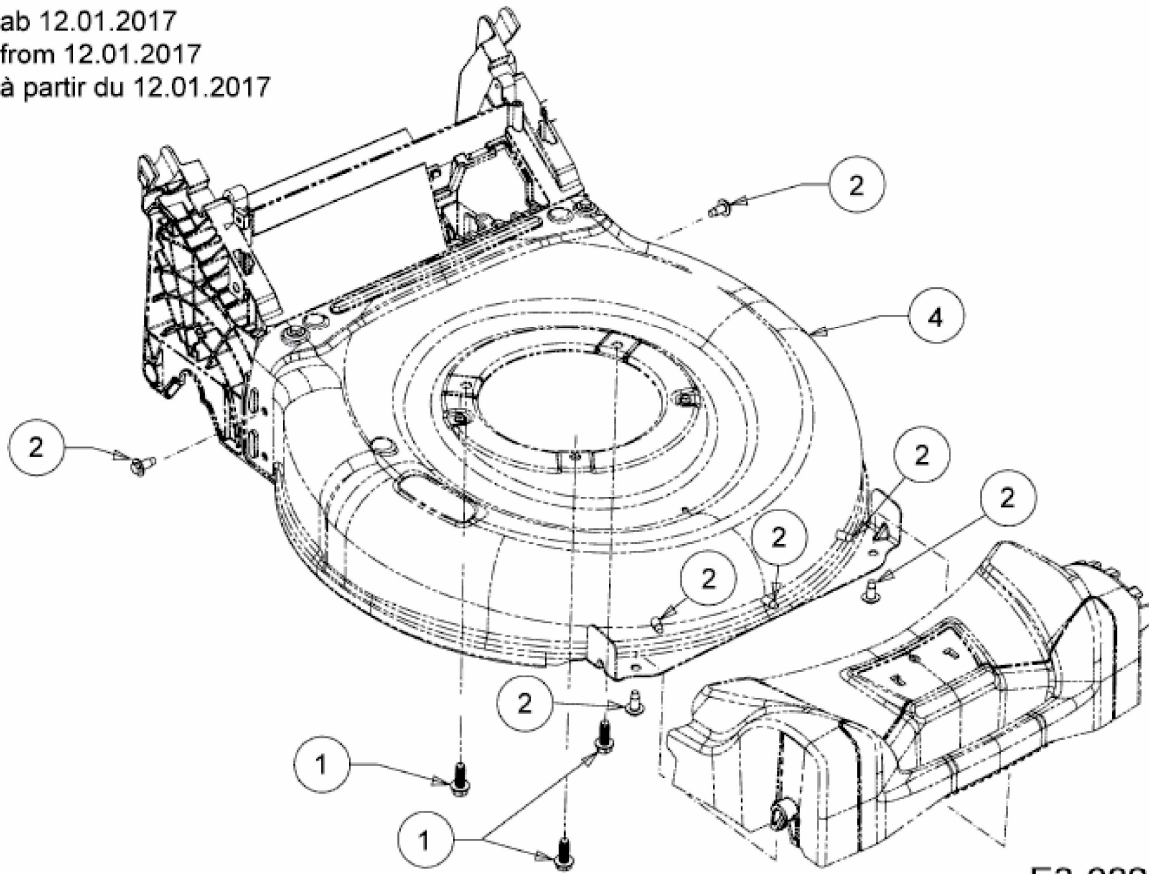

E3-08237C-02