

B 53 HMA > 12B-868F694 (2012) > SCHNITTHÖHENVERSTELLUNG

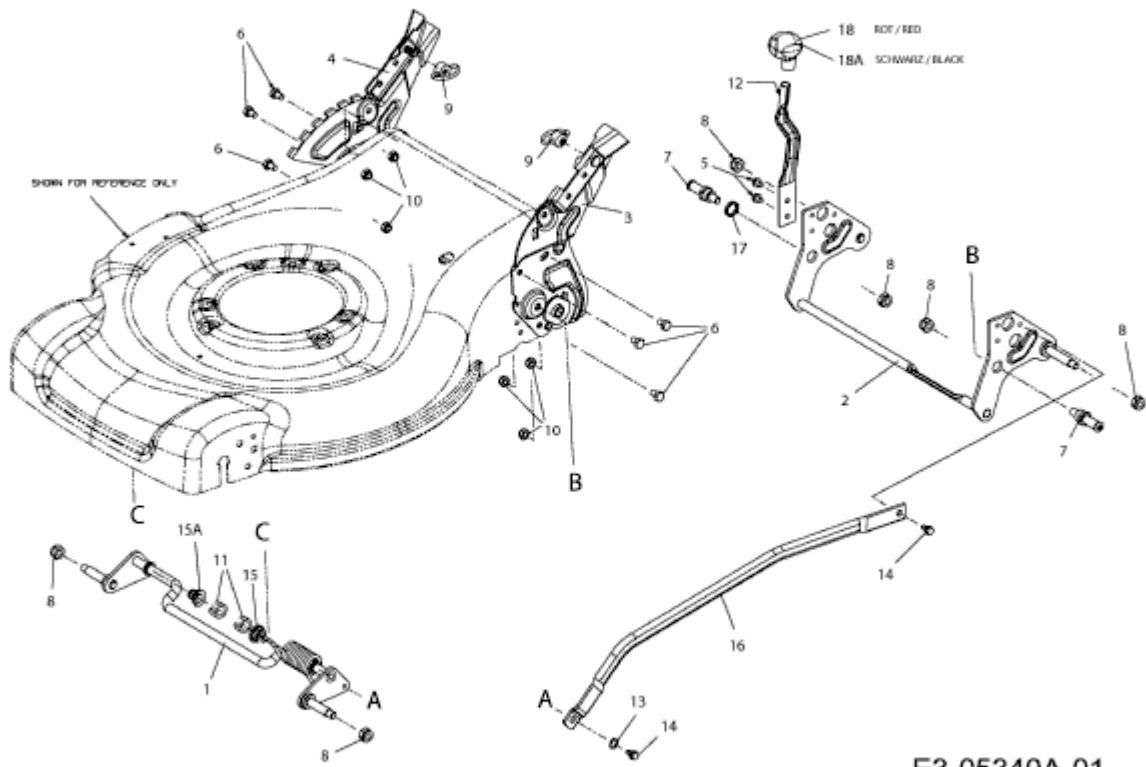

E3-05340A-01