

B 53 HMA > 12B-868F694 (2012) > MULCHSTOPFEN, LEITBLECH VORN

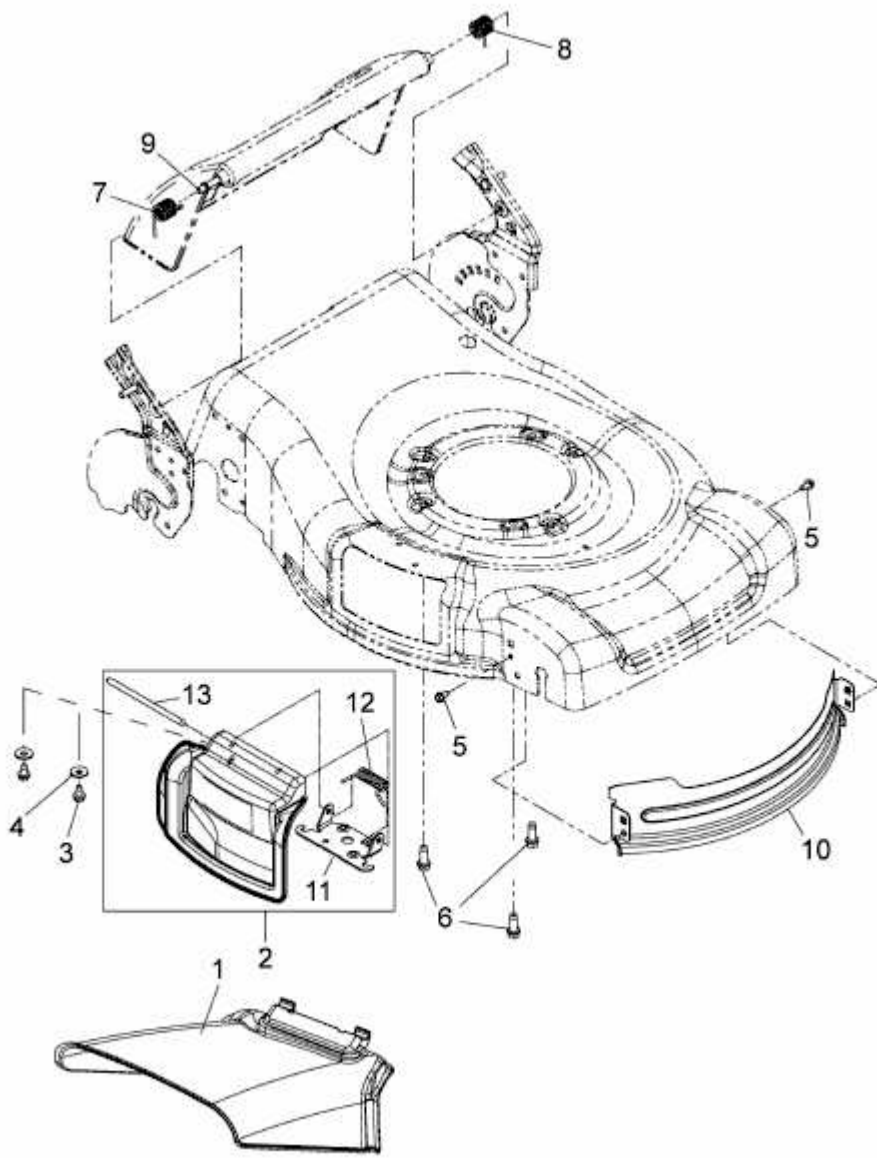

E3-05335A-01