

53 SPHWMB > 12B-858R676 (2013) > SCHNITTHÖHENVERSTELLUNG

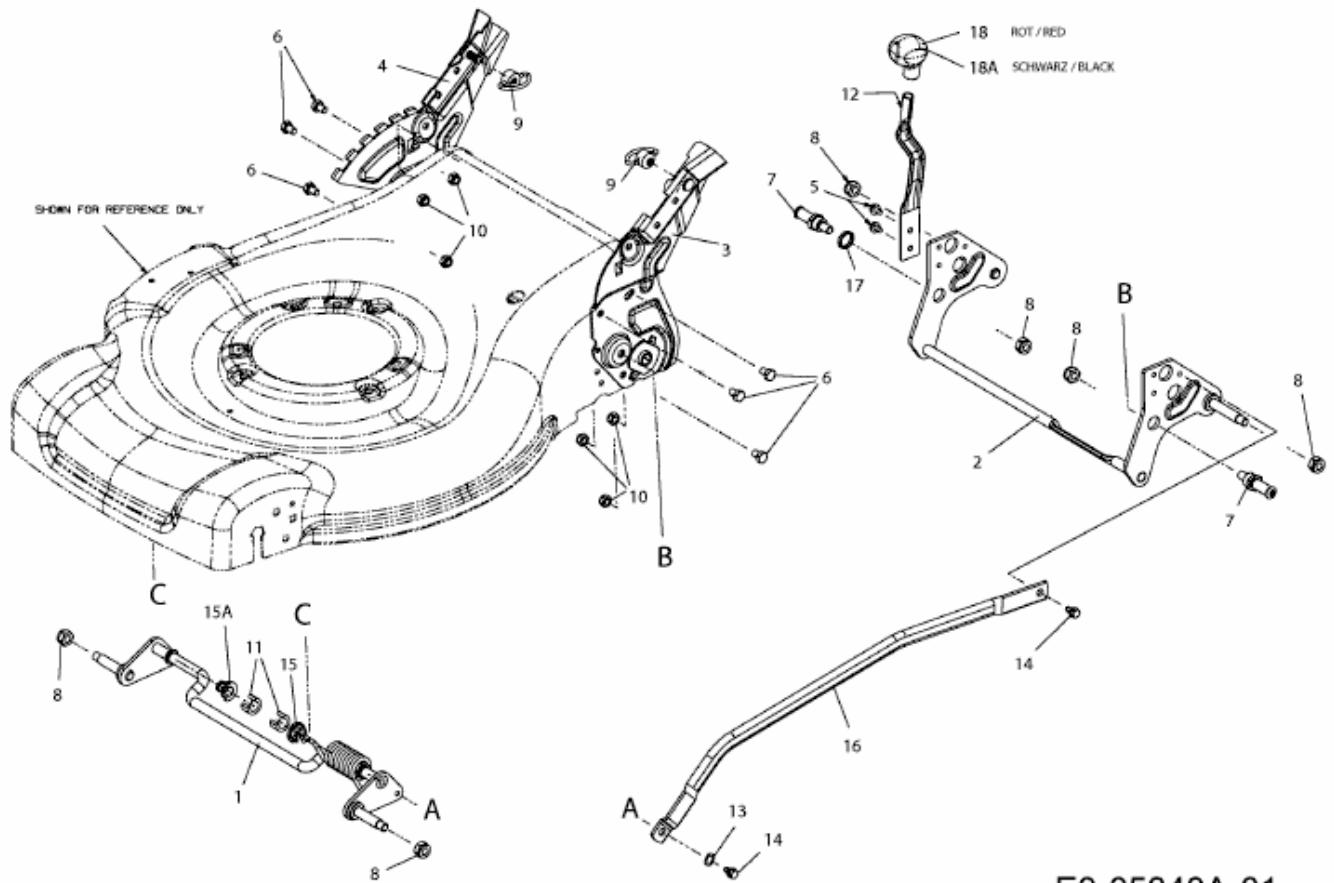

E3-05340A-01