

MF 19 SB > 12A186K695 (2012) > MÄHWERKSGEHÄUSE

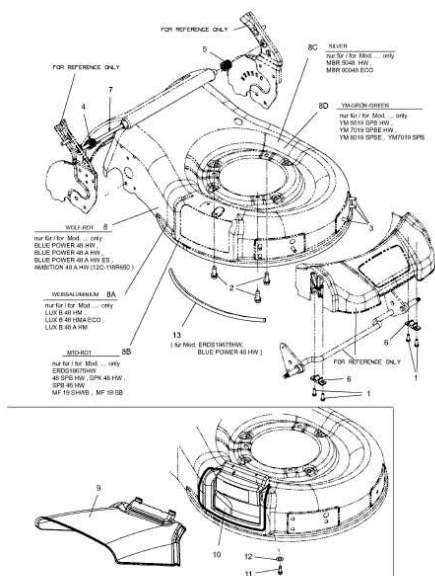

E3-05523A-01