

YM 7019 SPB > 12AI186K643 (2011) > SCHNITTHÖHENVERSTELLUNG

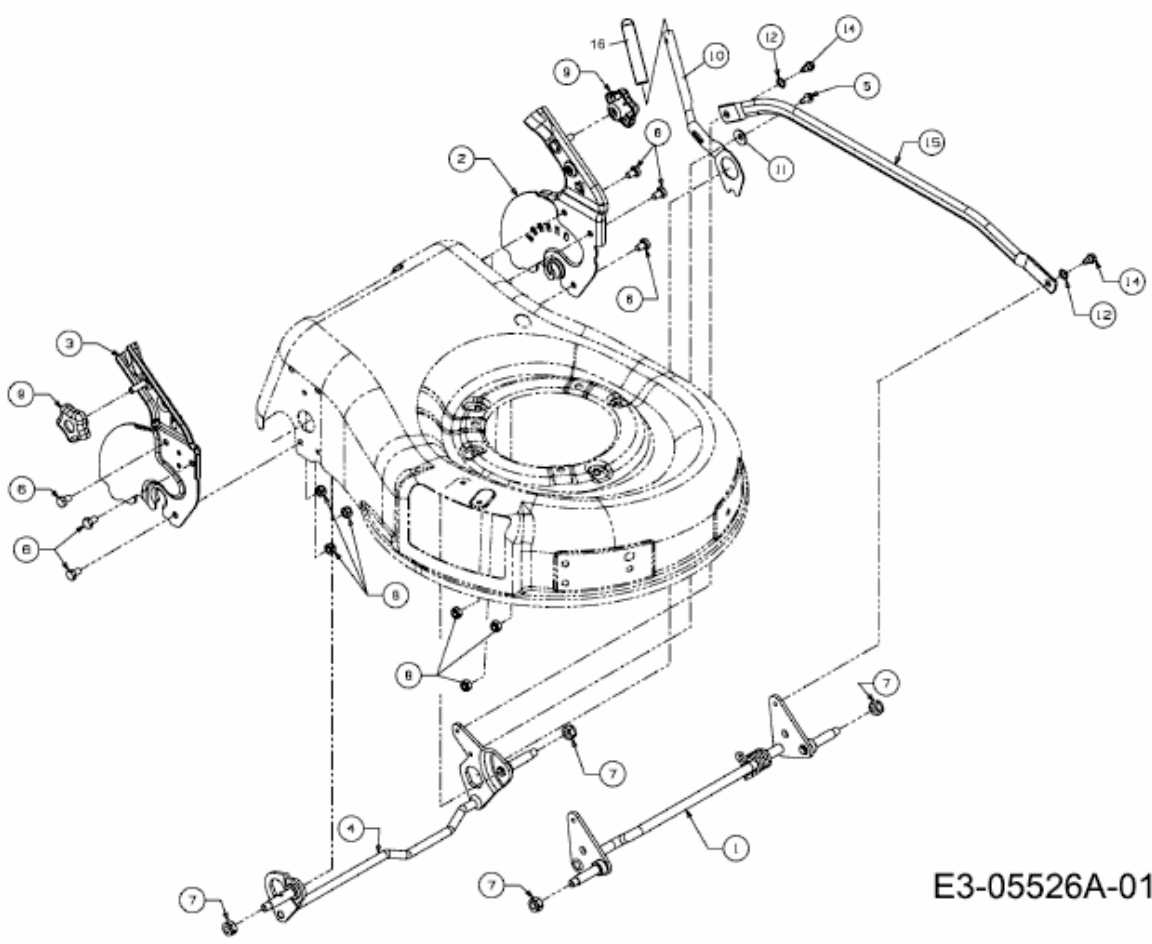

E3-05526A-01