

MF 19 SHWB > 12AI126K695 (2011) > MÄHWERKSGEHÄUSE

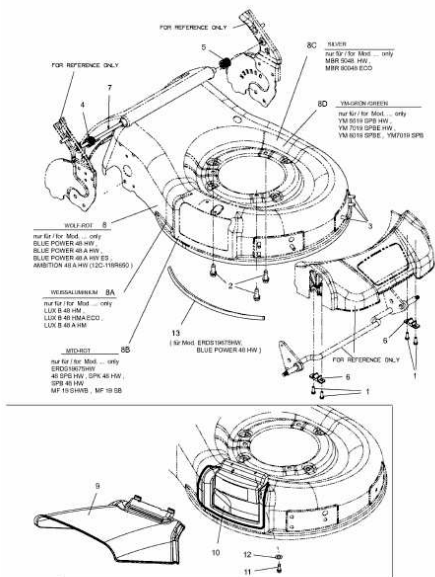

E3-05523A-01