

ab 01/12/2017
effective from 12/01/2017
à partir du 01/12/2017

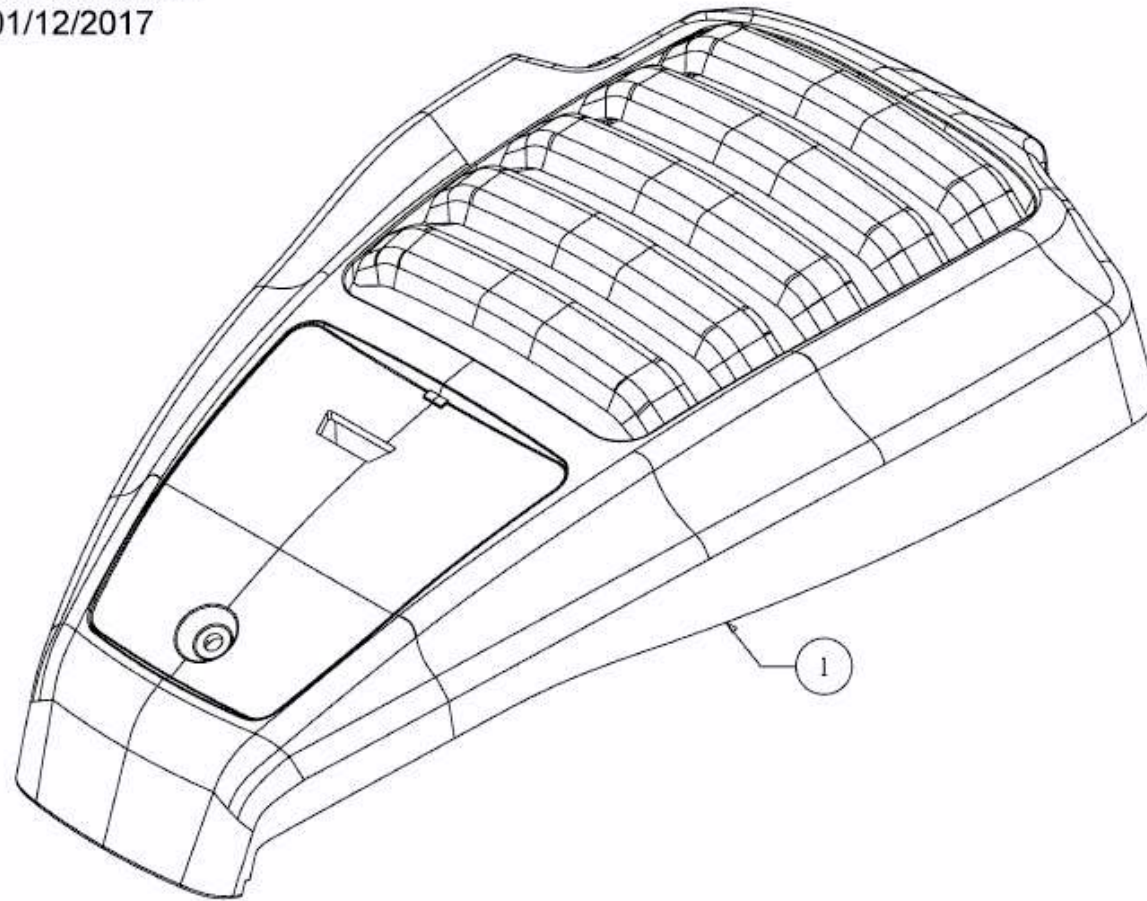

E3-00065A-02