

bis 30/11/2017
until 11/30/2017
jusqu'au 30/11/2017

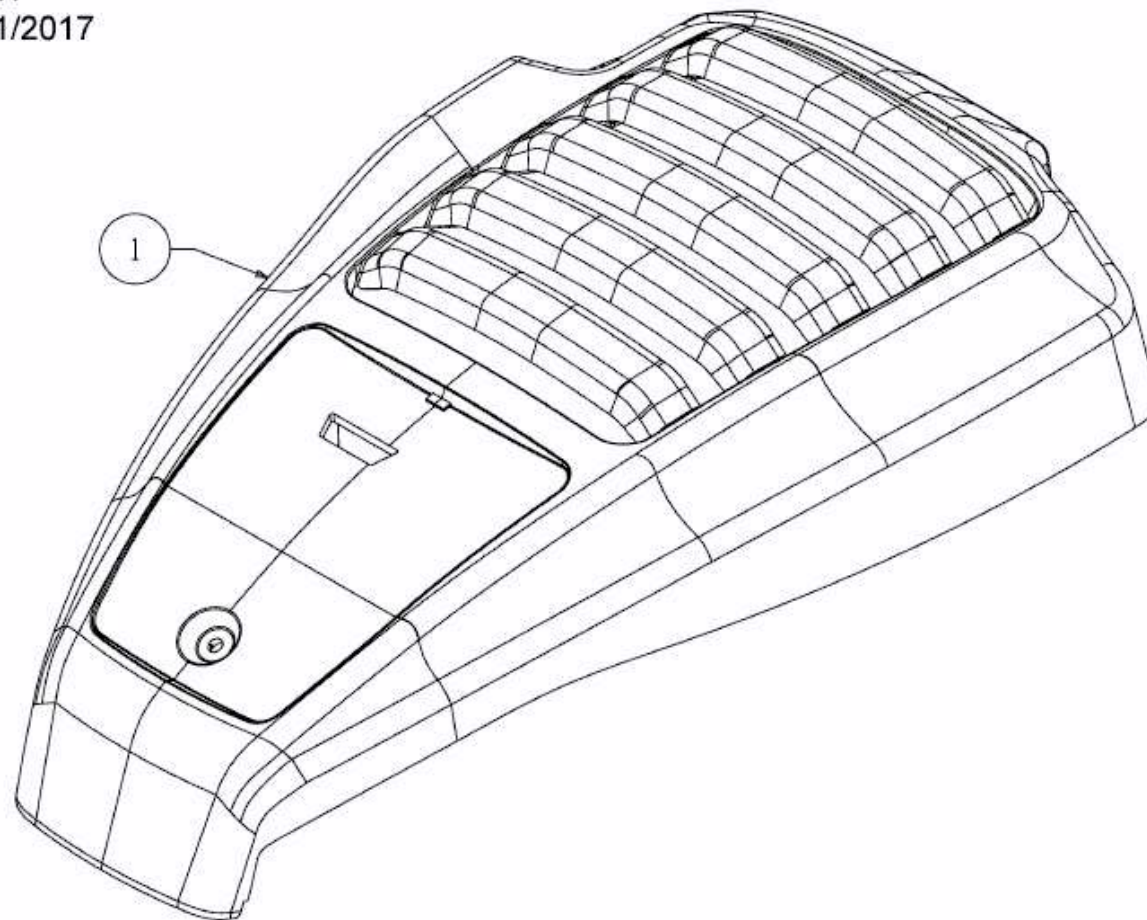

E3-00064A-02